

**Water and Wastewater Engineering**  
**Dr. B. S. Murty**  
**Department of Civil Engineering**  
**Indian Institute of Technology, Madras**

**Intake Structures and Pumping Installations**  
**Lecture # 40**

In this lecture we will discuss about intake structures and pumping installations which are an integral part of any water distribution network or they could be a part of sewerage systems also. The pumping is required in water supply systems to transport water from source to the treatment plant. Source could be at a lower elevation and treatment plant could be at a higher elevation. So we need to lift the water from a higher elevation so we need pumping for that. We also need pumping because we have to get over the frictional losses that could be coming in the pipeline.

(Refer Slide Time: 01:40)

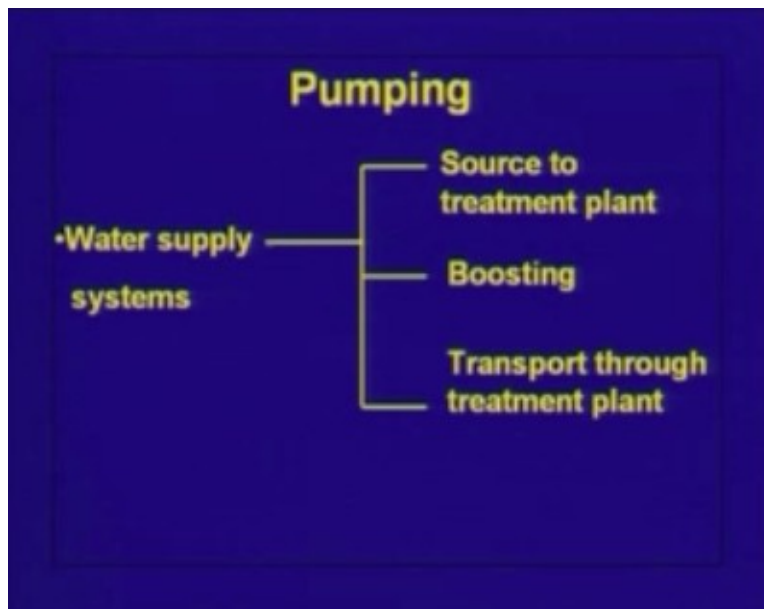

Many times in water distribution network because the pressures could be very low and we have to meet that minimum seven meters of head of residual pressure and we need to boost up these pressures so the pumping is also required to boost up pressures in water distribution networks in certain cases. We also need pumping in water distribution networks to transport water through treatment plants because a lot of energy loss occurs in **piping** so we have to get over these frictional losses and we need to have pumping for transporting water through treatment plants.

(Refer Slide Time: 02:40)

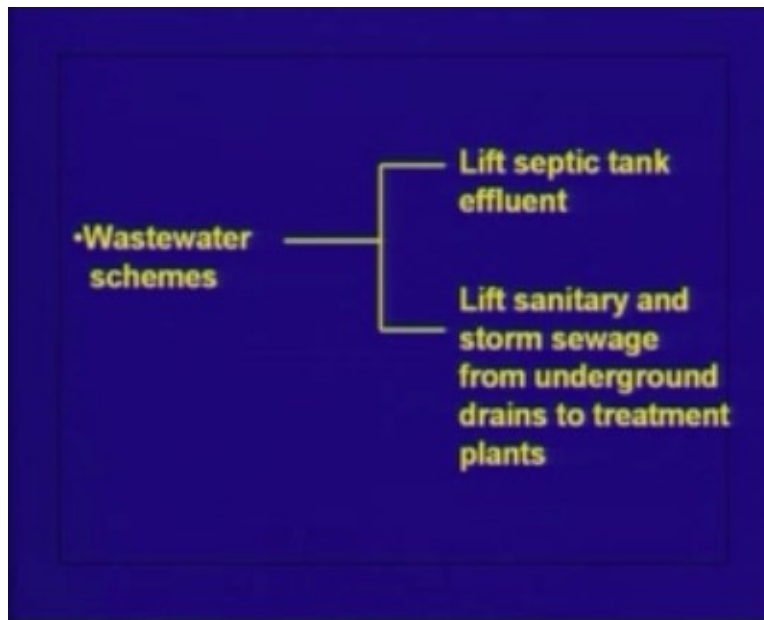

Pumping is required in wastewater schemes also to lift septic tank effluent from a lower elevation to a higher elevation. Many times we have to lift sanitary and storm sewerage from underground drains to treatment plants which are above the ground. In sewerage systems we also need to lift water from a lower elevation to higher elevation if the drain slope is much higher than the slope of the prevailing ground. In such a case over a distance the drain will be buried deep inside the ground but that will be very economical from the point of view of constructing and installation. Also it is difficult to maintain such pipes so we have to bring the drains to a higher elevation. In such cases we need to lift water from a lower elevation to higher elevation in wastewater schemes. There also we have the requirement of pumping.

Before we go and look at the pumping we look at the intake structures which are the first part of any water supply scheme. Intake is a device or structure to be placed in a surface water source to permit the withdrawal of water.

(Refer Slide Time: 03:55)

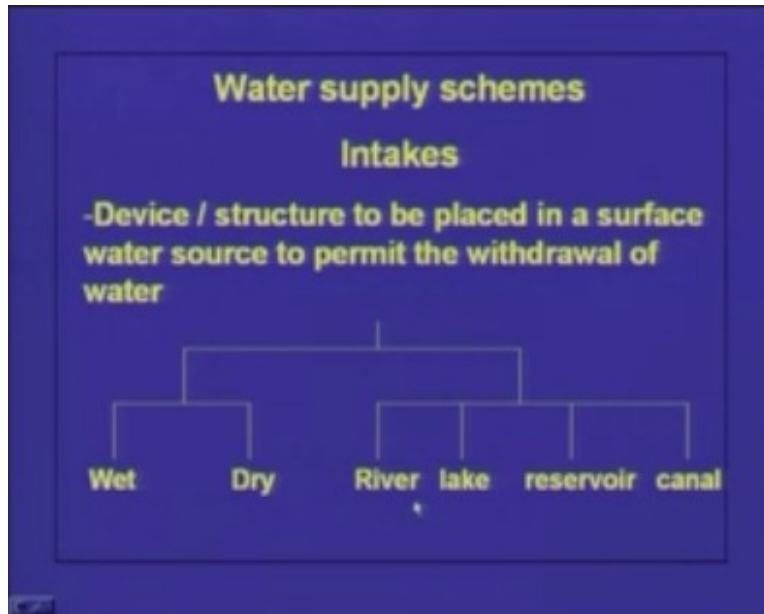

The intakes could be wet intakes or dry intakes depending upon whether the water is temporarily stored in that intake structure or not. Again intakes could be river intakes, lake intakes or reservoir intakes or canal intakes depending upon the source from which we are taking the water. For example, in this figure you see this is a river intake, here we have a bank and this is the river here (Refer Slide Time: 4:20) so the intake is almost inside the river and this is the high flood level, my pump or the pump house should be above the high flood level to be protected from the flood damage.

(Refer Slide Time: 05:20)

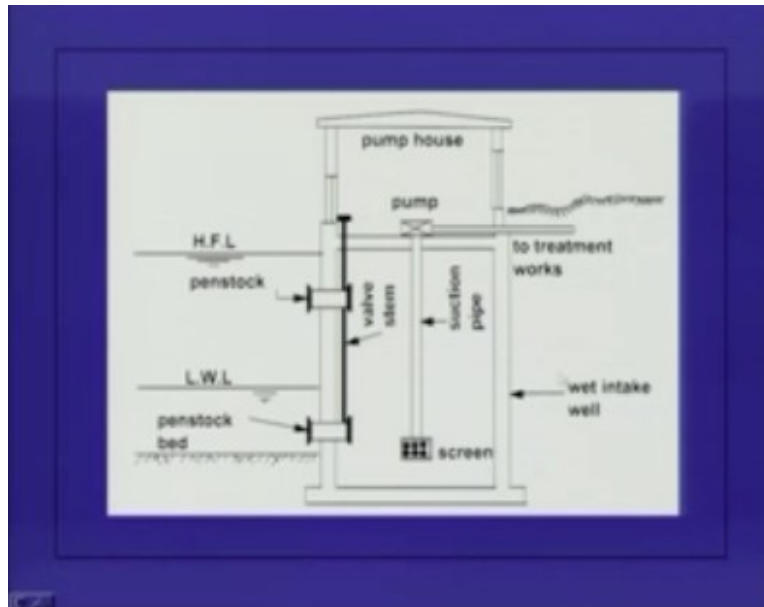

I also have this low water level. My intake structure should be able to draw water even when water is at a low water level. So we have two different pipes here which can draw water from the river to the intake structure that is a high level penstock and a low level penstock and there is a screen here at the front of the penstock this screen is preventing the debris from entering into the intake structure or entering into the treatment works.

There is a pump here, (Refer Slide Time: 5:10) the suction pipe of the pump is like this and this is the screen here which is again having the function of screening the fine material from entering into the suction pipe and consequently into the pump and then damage the pump. Now this level here the screen level or the bottom level of this suction pipe should be below low water level and there should be some sufficient head available here otherwise there could be an air entrainment.

This is called an intake well (Refer Slide Time: 5:40) and the water level in the intake well be slightly lower than whatever is the prevailing water level in the river. like for example if this is a high flood level and the water level is at this location in the river then the water level in the intake well will be slightly below that so that difference in the head accounts for the head loss in this piping system.

Now we also have a valve here which can be used to control the entry of water from the river into the intake well and this is the pump house and the delivery from the pump is taken to the treatment works. So this is a wet intake well system for a river intake. You see the next type of river intake.

(Refer Slide Time: 07:05)

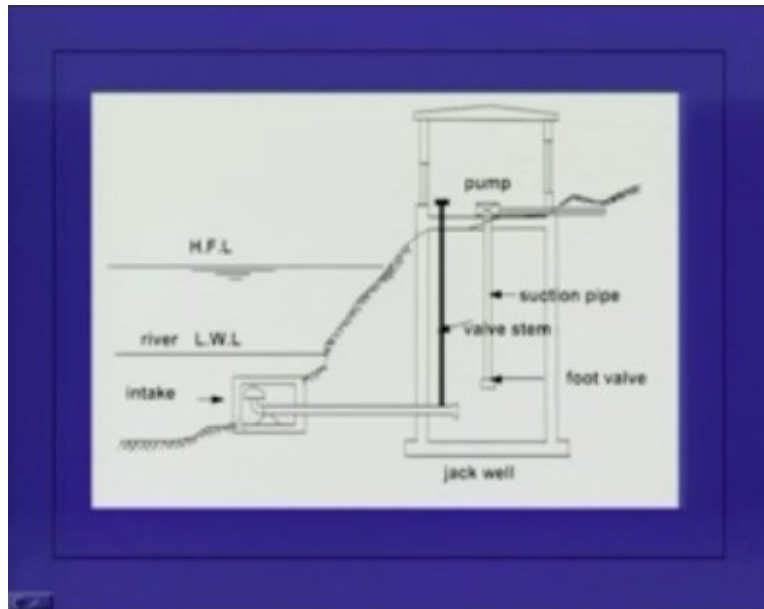

This is called a jack well and here we keep the pump house not inside the river away from the river on the banks not too far away but slightly away from the banks. In this case here you have this intake structure, now this intake structure is placed much below the low water levels so that water can enter in the well even during the low flow season. Here this is the intake pipe (Refer Slide Time: 6:50) and there is a screen here which screens the debris from entering into the intake well or jack well and we have a pump here which has a foot valve. Basically this foot valve is required for priming of the pump and this foot valve or the low end of this suction pipe should be below the river water level.

There is a valve here (Refer Slide Time: 7:15) which can be operated so that I can control the amount of water coming into the intake well and the pump house is much above the high flood level so that the flood damage to the intake structure is minimized and the delivery from the pump is taken to the treatment works. This is another type of intake structure or river intake structure.

(Refer Slide Time: 08:05)

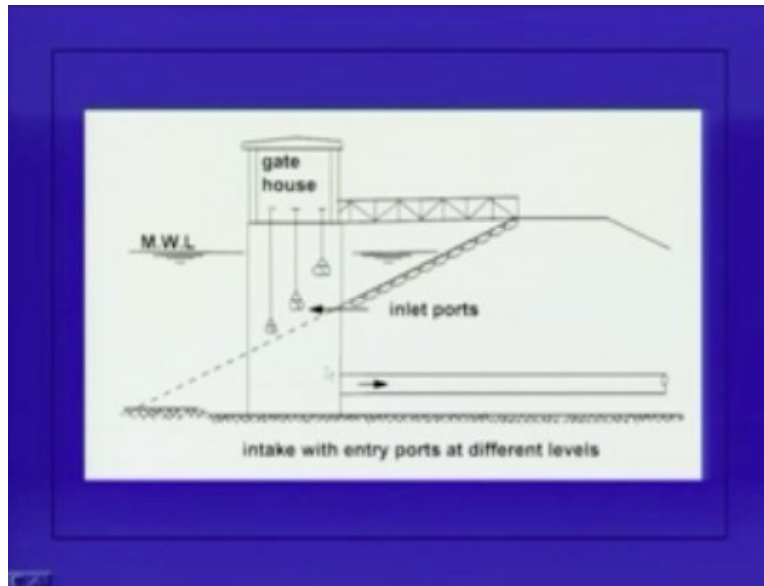

Now we will look at the intake structure the kind of intake structure we adopt when we want to take water from a reservoir. Here we have the reservoir and this is the earthen dam or embankment that is basically containing water in the reservoir. We want to take this water to the treatment works and here we put this intake structure, this is the intake structure (Refer Slide Time: 8:10) and the water can enter into this intake structure through the inlet ports shown here which are placed at three different levels. So water can enter into the intake structure from any of these inlet ports and then the control flow into the intake structure is done by these gates which we call the gatehouse and we need a foot bridge from the embankment to the gatehouse and water which enters into the intake structure is carried through this particular pipeline to the treatment works. **Either**, I can have a pump here if I need to lift the water or it can flow by gravity to the treatment works. So this is an intake with entry ports at different levels.

(Refer Slide Time: 09:30)

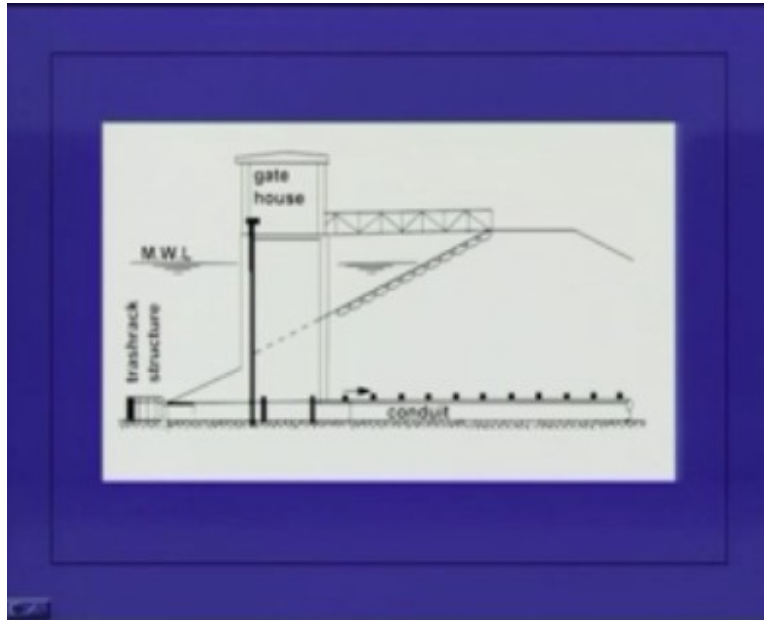

This is another type of an intake. Here there is only one entry port and not too many entry ports. The water enters the intake structure and then it goes through the conduit to the treatment works. I can have a pump house here if it is required. but the main point is water enters into this conduit or into this intake structure through only one port and we have a trash rack structure here which will prevent the entry of debris into this conduit or into this intake structure here and this entry port is kept at the bottom of the reservoir so the water can enter into this conduit even when the water level in the reservoir is very low.

(Refer Slide Time: 10:30)

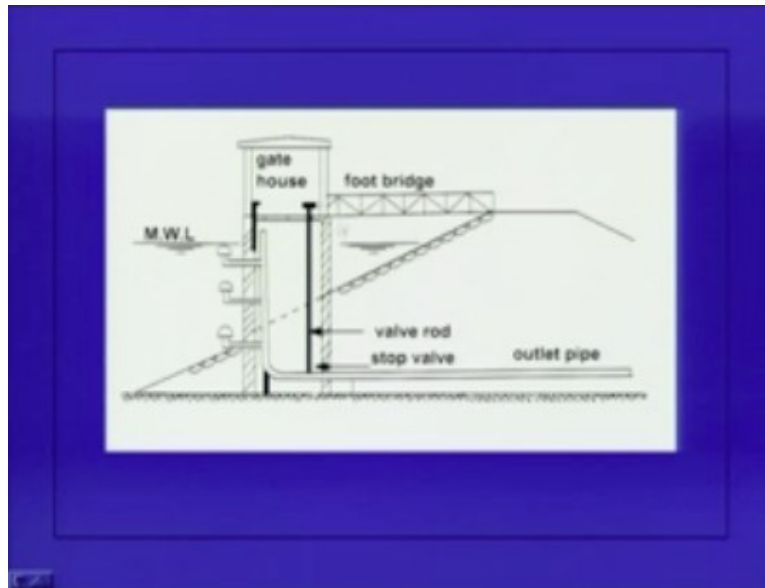

We have another type of intake structure. This is what we call a dry well intake structure or dry intake. It is dry intake because the water is never stored in this intake structure itself. I have this outlet pipe here which is coming and then entry into this outlet pipe is through this vertical riser and there are multiple entries into this vertical riser which take water from the reservoir and then there is a strainer and all the fine material and the debris is not allowed to enter into this pipe. The ports are at different levels so water enters into the riser and then directly flows through this outlet pipe. That way there is no which is stored in this intake structure at all. We have a valve rod here to control the flow into the outlet pipe. Therefore, this is completely a dry well or a dry intake structure to take water from a reservoir. We may also have a reservoir where the water is stored behind a gravity dam.

(Refer Slide Time: 10:50)



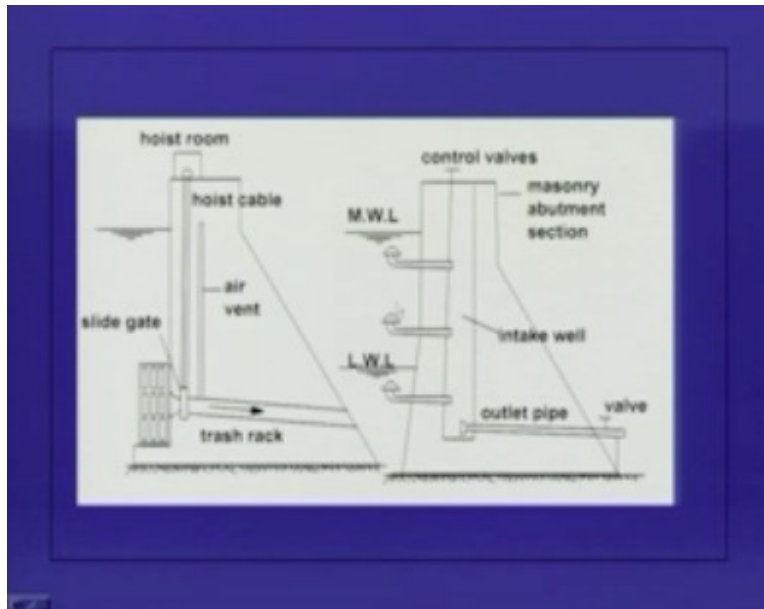

So, if I have a gravity dam like this then I can have one pipe the intake pipe which is going through the body of that gravity dam and there is a bell mouth here so that there is a smooth entry into this intake pipe and at the entrance to the bell mouth we have this trash rack structure which prevents the entry of debris and then suspended matter into this inlet or intake pipe and the flow into the intake pipe itself can be controlled by a gate. This is the hoist cable for the gate (Refer Slide Time: 11:30) and the gate itself can be controlled from the top of the dam.

We also need an air vent here that is meant for expelling air during the maintenance period. Again we can also have another type of intake for gravity dams or to take the water from the reservoirs behind a gravity dam. In this fig. a there is only one port of entry and it is kept at the bottom of the reservoir. Here we have multiple entries and one entry is below the low water level, one entry at the middle and another entry is below the high water level maximum water level and this water enters into this intake well, this is the intake well I am showing so this intake well is always full of water so it's a wet intake, water is entering through these inlet pipes into this intake well and outlet pipe goes from this intake well and the flow in the outlet pipe can be controlled through the valve and flow into the intake well can also be controlled through these control valves and this is basically the **masonry abutment section**.

So, for taking water out of a reservoir behind a gravity dam either I can follow this particular arrangement (Refer Slide Time: 12:51) for intake or this particular arrangement for the intake. We can also have what we call a lake intake structure. In the lake intake structure we take the water from the bottom of the lake.

(Refer Slide Time: 13:50)

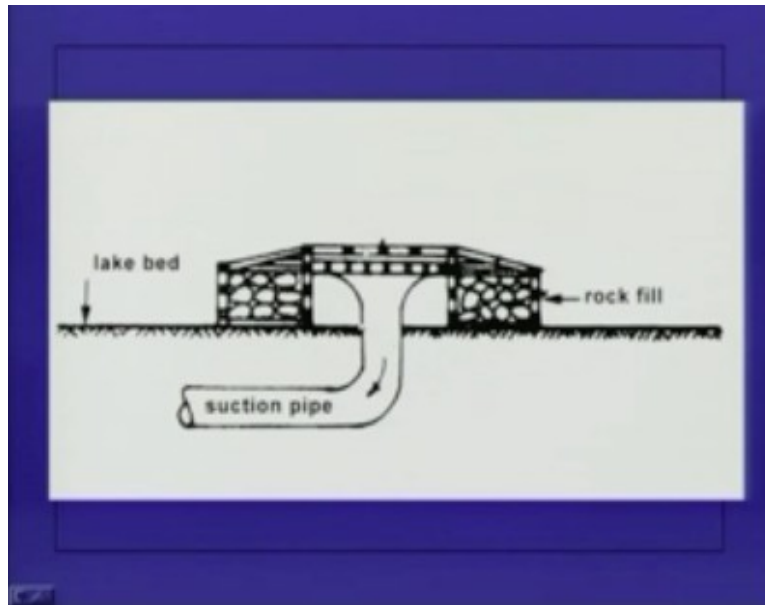

This is the suction pipe and the suction pipe is the one which joins the suction side of the pump and this is the lake bed and there is a bell mouth entry for this suction pipe so that the water enters smoothly into this suction pipe. Here there is planking and over that there is a CI grating. These are the ones which are preventing the entry of debris into the suction pipe and this whole intake is protected from any damage from the sides and top using this plank as well this rock fill here. This intake (Refer Slide Time: 13:40) should be operated in such a way that there is a minimum water level above this suction pipe otherwise there could be air entry. That is a very important point in the design of this intake structures which we will discuss in detail little later.

(Refer Slide Time: 15:20)

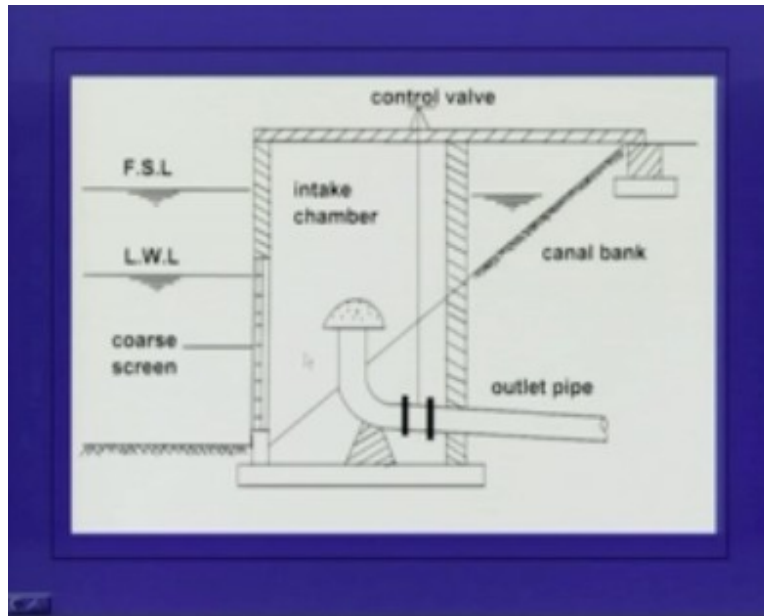

We can also have an intake structure of this nature. This is what we call a canal intake structure. In the canal intake structure you put the intake structure on the canal bank. These canal intake structures are normally used for water distribution systems which are catering to a small community. Here we have this outlet pipe which is supported on a thrust block like this and the top of this outlet pipe we have the screen which will prevent the entry of debris into this outlet pipe and there is a control valve here kept on the top of this intake chamber which we can access from the canal bank to this bridge and we can operate this control valve and then control the amount of water that is flowing into the outlet pipe.

Here (Refer Slide Time: 15:00) the water entry into the intake chamber itself takes place from this side. From the canal the water enters like this to this intake chamber and there are coarse screens here which will prevent the entry of large particles or large debris from entering into the intake chamber. This is a fine screen which will prevent the entry of fine material into the outlet pipe. Now the coarse screen or the total depth of this entry is kept such that the top of this entry point is above the low water level so that water can flow into this even when we have minimum amount of water in the canal. This is what we call a canal intake structure.

There are certain points that we should consider while designing these intakes. First of all we should worry about where we are going to place these intakes. So the intake location is an important consideration in the design. We should locate these intakes wherever best quality of water is available. We cannot locate the intakes where we don't have the best quality or the water quality is very poor.

(Refer Slide Time: 16:35)

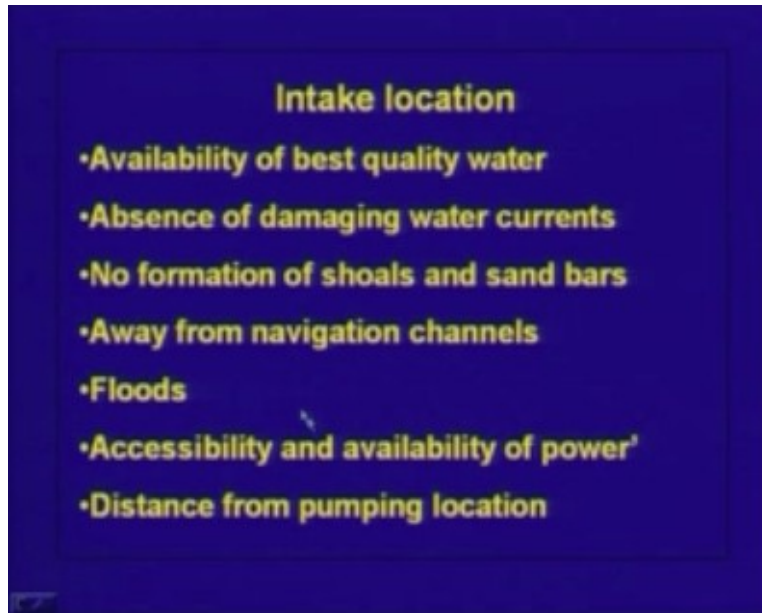

The location where we install these intakes should be such that it is protected from the damaging water currents. Water currents should not be very swift such that the water load or the dynamic load from the water on the intake structure is significant and it can get damaged during floods. Also it should be located in such a place there is no formation of shoals and sand bars because if shoals and sand bars form in and around the intake structures then the working of the intake structure is affected significantly. The entry of water into the intake structure is not going to be very smooth and sometimes what happens is the shoals and bars form around the intake structures then the river can tend to meander and then we will not have any water near the intake structure particularly during low season. So we should not locate the intake structures where there is a possibility of formation of shoals and sand bars.

We also have to locate these intake structures away from navigation channels. because if the intake structure is close to the navigation channel then the ships and other vessels passing through this navigation channel may go and then hit the intake structure and may damage it. So we have to place this intake structures or locate this intake structures away from the navigation channels. Again the location of the intake structures also depends upon what kind of floods that are occurring in the river and what kind of flood damage that could come on the intake structure this is very very important.

As we have seen earlier we may locate the intake structure right in the river or we can locate the intake structure a little far away from the river. But if we locate the intake structure very far away from the river and my intake pipe is very long then whatever variation that may come in, in the pumping operation the river will not be responding with very quickly because the river is now quite far away and there will also be energy losses in this intake pipe so the water level in the intake well will be much lower than the water level in the river which is not very good for pumping because the pumping costs would be high. So the location of the intake structure as far as protecting them from the flood damage is a very important consideration in locating them.

Now, again wherever we put the intake structure we should be able to provide the power for the operation of the pumps in intake structure. Thus, availability of power to the intake structure is very important because if power is not available near the intake structure then we have to operate it with battery but that is not a very good condition.

Accessibility to the intake structure is also very important because if it is not accessible then certainly the maintenance will be very bad. So accessibility and availability of power are very important considerations in locating the intake structures.

Distance from pumping location: Sometimes the pumps cannot be placed within the intake structure itself as they have seen in some earlier diagrams. If the pumping is a little far away from the intake structure it has to be considered because of the hydraulics of the flow, how much of friction loss will be occurring in the intake pipe and so on.

What are the design considerations for these intakes?

First of all we have to provide for withdrawal from more than one level, this is very important. In some of that I have shown earlier we have the multiple entries. This will help in proper operation of these intake structures during the flow variation. Sometimes the water level in the source could be very high, sometimes the water level in the source could be very low that has to be taken into consideration and that is why we provide for withdrawal from more than one level.

We also have to provide under sluices to release less desirable water. under sluices are the ones which are provided almost close to the bottom of the reservoir or bottom of the canal or the river and they should be placed very close to the intake structures and these under sluices should be used for removing undesirable water so that only a good quality of water enters the intake structure and the pumping installation.

Intake: If we have to locate near a navigable channel and we cannot avoid it lets say then we have to protect it against blows from the ships by providing clusters of piers. So even if the ship comes very close to the intake structure it hits against these piers but the intake structure itself is safe.

(Refer Slide Time: 21:40)

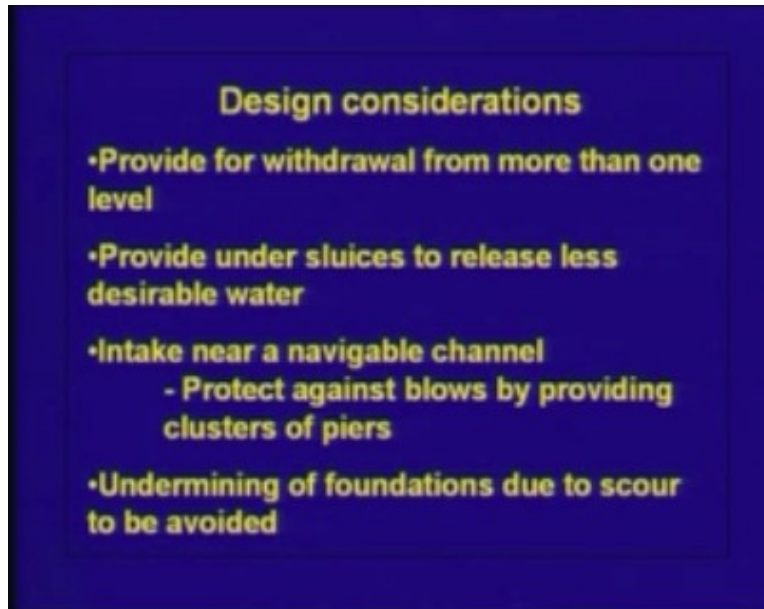

Undermining of foundations due to scour should be avoided. This is very very important, because if you have located the intake structure inside the river like the first option first intake structure that I have shown so in such a case during floods what happens is because the velocity is very high the sediment that is sitting on the bed can get scoured and if the sediment gets scoured during the high flood flows then the river bed level itself is going to go down. If the river bed level goes below the foundation level of the intake structure then the intake structure can get washed away very easily. So, undermining of foundations due to scour should be avoided.

It's very similar to design of brick piers. The foundation level for the brick piers should go below the maximum scour that is expected during the high floods. Same kind of principle one should use for finding out what should be foundation level or what is the maximum scour level and the foundation level should be below this maximum scour level that can come during high floods, that is very important otherwise the intake structure can get washed away very easily during high floods.

The other important point is the overturning pressure due to slit deposition. Whenever we have an intake structure it is creating an obstruction to the flow. This is particularly important when the intake structure is located within the river or within the canal itself. Now, on one side of this intake structure there could be deposition or sand and slit deposition and on the other side there could be little scour so there will be differential earth pressure that is going to act on this intake structure and that can result in overturning pressures. When we design intake structure or when we do the structural design of this intake structures these overturning pressures due to slit deposition should be given due consideration.

The other important parts of the intake structures are the coarse screens. These coarse screens should prevent entrance of large objects into the intake structure and into the pumping scheme. The fine screens are also used and the purpose of fine screens is to

exclude small fish and small objects from entering or prevent the entry of small fish and small objects into the pumping scheme.

(Refer Slide Time: 24:30)

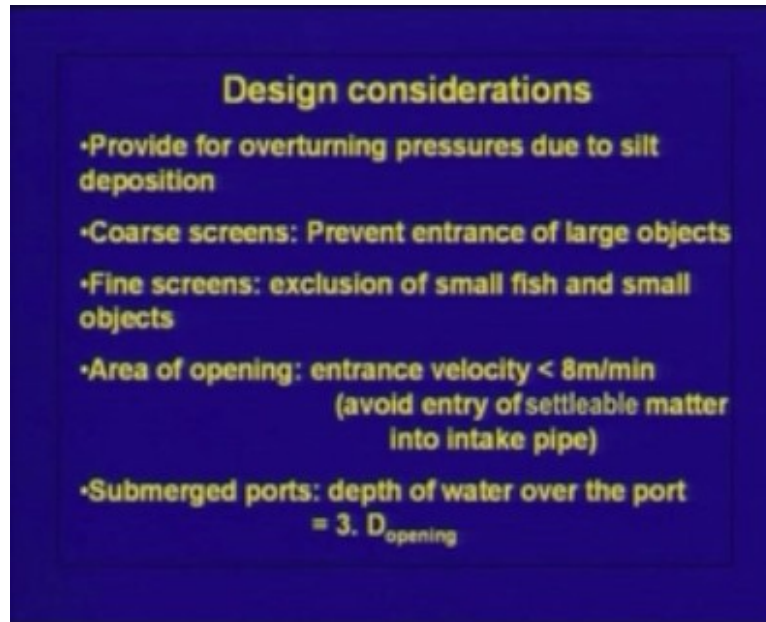

The area of opening of these screens should be such that the entrance velocity is less than 8 m per minute. If the entrance velocity is very high then large objects also could be suspended due to the turbulence and these materials can easily enter into the intake structure. So the entrance velocity should be less than 8 m per minute so that the entry of **settleable** matter into the intake pipe is avoided. And when we have submerged ports then the depth of water over the port should be more than three times the diameter of opening. What happens is we have submerged ports which are very similar to what you see in a sink.

In your kitchen sink if there is not enough depth above the bottom opening of your sink then you will see this air code that is forming and then air can get sucked into the inlet pipe. So, to prevent that vortex formation to prevent the air entry into the inlet pipe if there is a submerged port then the depth of water above the port should be a minimum of three times the diameter of opening. This is very very important because air entry into the inlet pipe or intake pipe and subsequent transmission of this entering air through the suction pipe to the pump can cause damage to the pump in no time so we should avoid this.

The other important design considerations are if you have under water conduits then we should use a standard cast iron pipe, steel pipe or a concrete pipe and the velocity of these conduits should be about 60 to 90 cm per second. We should not allow a higher velocity through the ports. In fact the velocity through the ports should be lower than the velocity in the conduit and that is the reason why we always have a bell mouth entry into these conduits. Again the velocity in the conduit should be around 60 to 90 cm per second.

(Refer Slide Time: 27:05)

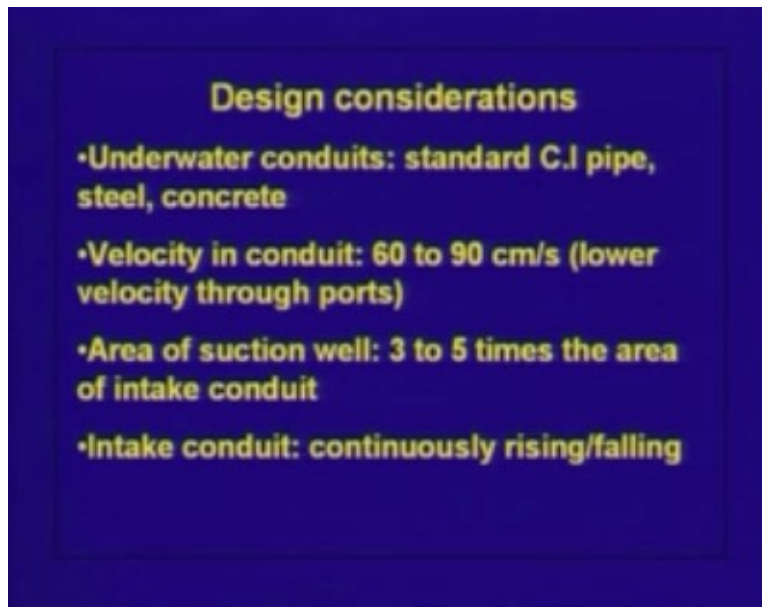

The area of suction well or the suction well is providing some kind of a temporary storage. So the cross sectional area of the suction well is another important consideration in the design. This should be around three to five times the area of intake conduit. The intake conduit itself should be continuously rising or falling, it should not have any bends because any bends will cause flow disturbance and it will increase the head loss. That way the water level for a wet intake will be much lower than the water level in the river and that is not what we want. So the intake conduit should be either continuously rising or continuously falling.

(Refer Slide Time: 27:55)



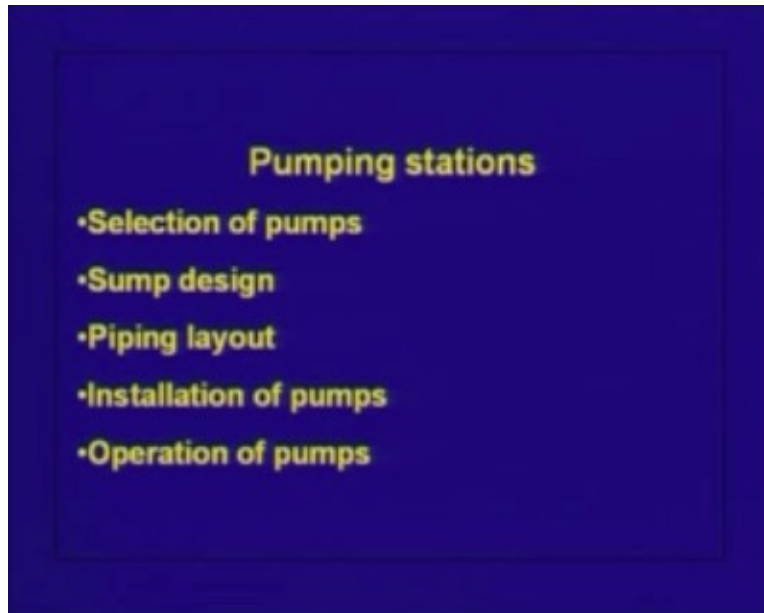

Now let us look at the next part which is the pumping station. In the design of pumping stations few things have to be given due importance. The first part is the selection of the pumps. Then we have the sump design which is very very important, how do we place these pumps in the sump. In fact many of the pump manufacturers insist that a model study should be conducted while designing the sump and only if the sump design is satisfactory the pump manufacturer will give you guarantees regarding the performance of the pumps because the performance of the pump as far as the efficiency is concerned, the life of the pump is concerned is integrally dependent on the design of the sum. **So these two is what we look at in this particular lecture.**

The other important points in the pumping station design are the layout of the pipes within the pumping station, how do we install these pumps and how do we operate these pumps. But we look at in this lecture mainly on the selection of pumps and the sump design.

(Refer Slide Time: 29:30)

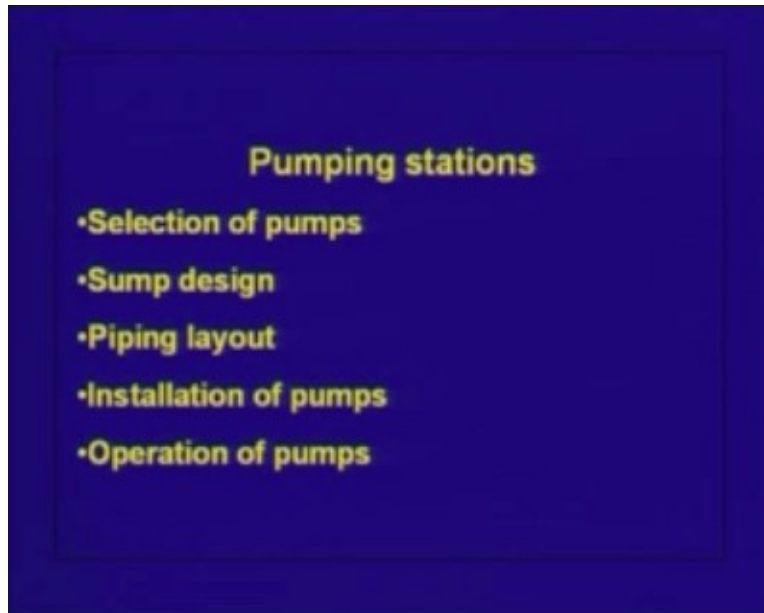

What are the different types of pumps available and which of these pumps are more commonly used in the water supply scheme and then sewerage systems. The types of pumps are centrifugal pumps, positive displacement pumps, for example, reciprocating pumps, the screw pumps, gear pumps etc are all positive displacement pumps, then buoyancy operated air lift pumps and sometimes we also have Hydraulic Rams. Among all these types of pumps the centrifugal and reciprocating pumps are more popular in water supply schemes and sewerage systems.

The first thing is we have to discuss regarding the criteria for pump selection. what kind of a pump we should select, what should be its size, should we select a reciprocating pump or should we select a gear pump or shall we go for a positive displacement pump or a reciprocating pump. This selection of type of the pump depends upon the nature of the liquid. It depends on whether we are pumping raw water or treated water whether we are pumping water for a water supply scheme or a waste water scheme or waste water collection scheme, if we are pumping in a wastewater collection scheme then we have to ask the question whether it is meant for pumping sanitary sewage or storm sewage. The nature of liquid is an important parameter in the selection of the type of the pump.

(Refer Slide Time: 30:40)

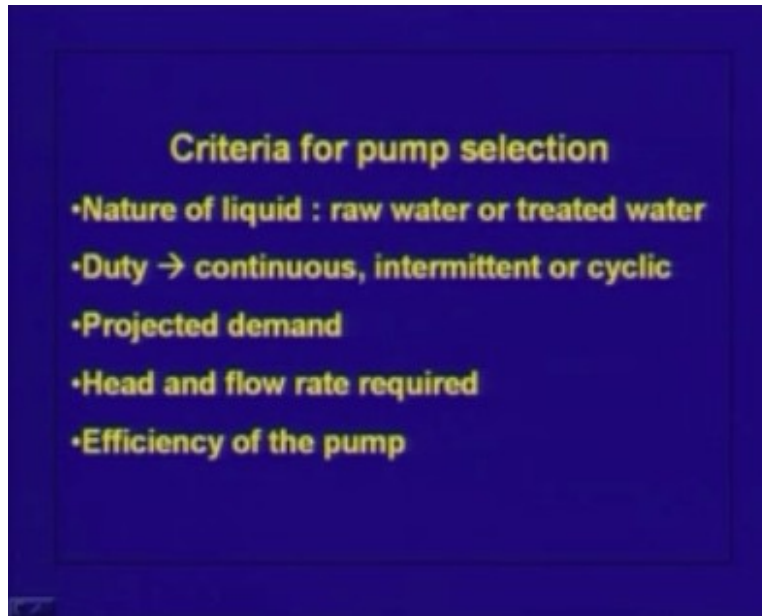

Then we have the operation of the pump or what we call the duty whether we are going to operate the pump continuously or intermittently or in a cycle fashion so the pump selection depends upon that factor also. The size of the pump depends upon what is the demand we are going to meet. We are going to design this pumping system not for the present use only but this pumping system should be able to meet the demands even in the future. So the projected demand is another important factor in the criteria for pump selection. So, over a period of years as the demand is increasing the pump should be able to operate and should be able to give same level of efficiency even when the demand increases in the future.

The pump selection depends upon what is the head over which the pumping has to be carried and what is the amount of flow rate that we want to realize. The head and flow rate required also affect very significantly the pump selection. The most important point is the efficiency of the pump. We are going to have this pumping operation over a long period of time may be for twenty years or thirty years and we may be operating it for may be twelve hours a day or even twenty four hours a day. In such cases the power is required to operate these pumps and not all the electric power that we supply to the pump is converted and is hundred percent used in lifting the water so the efficiency comes into the picture.

The efficiency of the pump should be very high so that the power consumed during the pumping operations is minimized. Again whenever we have a pumping station or pumping installation we may not be using only one single pump.

Let us say we want to lift the water over a small lift may be two meters or three meters but our demand or the pumping rate is very very high. Now we can do this with one single large pump which gives that very high discharge or we can do the same operation by using three or four more pumps which are used in parallel so that the head the lift given by all these individual pumps is same but when you add the discharge from each of

these pumps the total discharge meets our demand. That means we are operating these pumps in parallel. That is also an important consideration in selection of the pump particularly the number of pumps we need to have, what should be its size and so on and so forth.

In some cases we need to have for the same discharge the delivery point could be at a much higher level compared to the water level in the sump or the lift is very high. In such a case I can use a single pump which gives the required discharge as well as it is able to lift the water to a much higher elevation. Or I can use three or four more pumps in a series operation. That is the first pump will lift the water by a certain amount then the second pump takes over and for the same amount of discharge it lifts the water by another amount and so on and so forth. So whenever we are selecting the pumps and whenever we are doing this design of a pumping installation the number of pumps is important. Whether these pumps are operating in parallel or whether they are operating in series is another important consideration which we need to decide right away before we go and select the pump.

The other important considerations in pump selection are what are the different modes of installation, how are we going to install these pumps, what kind of space is available for us in the pumping station to install these pumps, how we are going to move the equipment and so on and so forth. Hence, these are also important considerations while selecting the pump.

(Refer Slide Time: 35:34)

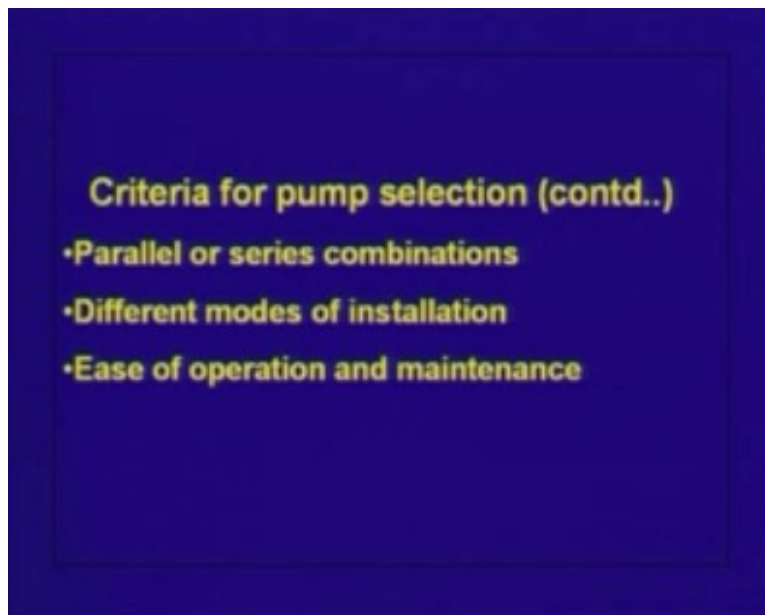

Finally we have the ease of operation and maintenance. The pumping installation should be such that we can maintain these pumping installations easily. We also have to know

the kind of operation whether it is easy or difficult because many times the operators are not well qualified to be able to implement very complex operating schedule so the operation should be such that it is easy to operate the pump and it is easy to maintain and pump selection many times is based on that criteria.

In the pump selection one single most significant factor or significant parameter or number whatever you call is the specific speed. Just like for flows in pipes Reynolds number is the most significant parameter or significant number or in open channels Froude number is the significant number. Whenever we talk about pumps pumping operations or pumping selection specific speed is a significant number that we have to consider.

Specific speed is defined as  $NQ$  which is equal to 3.65 multiplied by  $N$  where this  $N$  is the operating speed of the pump in revolutions per minute multiplied by square root of  $Q$  or  $Q$  to the power 0.5 where  $Q$  is the discharge through the pump or the flow rate through the pump should be taken in units meter cube per second divided by the rated head  $H$  to the power 0.75. This rated flow rate  $Q$  and rated head are the head end discharge that are realized when the pump is operating at its maximum efficiency point. These values (Refer Slide Time: 37:38) the rated head should be given in meters here and flow rate is in meter cube per second. It is very important to notice here that this is not a non dimensional parameter and this 3.65 is basically that is a factor coming for the units that we are using here.

(Refer Slide Time: 38:00)

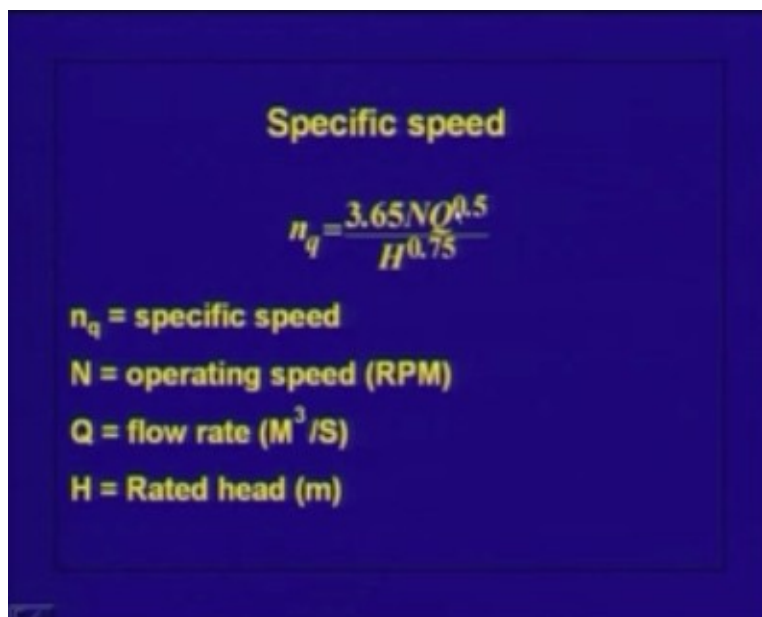

**Specific speed**

$$n_q = \frac{3.65 N Q^{0.5}}{H^{0.75}}$$

**$n_q$  = specific speed**  
 **$N$  = operating speed (RPM)**  
 **$Q$  = flow rate ( $M^3/S$ )**  
 **$H$  = Rated head (m)**

So, if you see the specific speed for the same pump given by another number you should understand that the person is using a different unit system. this is the unit system that we use for defining specific speed in our country or this is the one which is recommended by our water supply manual, our water supply and treatment manual given by the water

prevention and control of pollution act 1974 and the water prevention and control of pollution rules 1975 or it is given in the manual on water supply and treatment.

Specific speed: you can know the specific speed by knowing what is the rated head or the net pumping head that you are going to have and what is the rated discharge and you can put this operating speed that is let's say around 1200 RPM and so on. Then once you know the specific speed then you can select the type of the pump. For example, as the specific speed increases, in this diagram you can see, what is the efficiency that is achievable for different pumping rates.

(Refer Slide Time: 39:15)

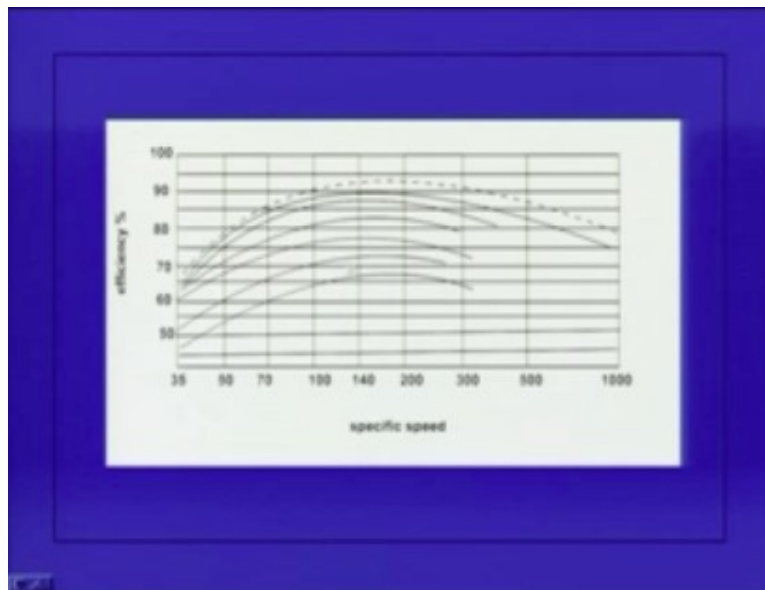

Here (Refer Slide Time: 39:16) this is the curve for 6.3 liters per second, this is the curve for 12.5 liters per second and so on and so forth. So the efficiency of your pump depends upon the amount of water you are pumping as well as the specific speed. This efficiency that is achievable or the maximum efficiency that is achievable for a given specific speed depends upon the design of the impellor which is shown in the next figure.

Here the impellor is called a radial flow impellor, the water flows radially on the impellor. On the other end it is called a propeller, here the flow takes place along the axis of the pump so this is the axial flow machine and this is the radial flow machine and typically if the specific speeds are low one should go for radial flow machines. The reason is one can achieve maximum efficiency by designing a radial flow machine as compared to the efficiency that can be achieved by going in for an axial flow machine. Thus, as the specific speed increases from 35 to 75 then to 130 where we go for a mixed flow impellor where the entry is radial and the outflow is in the axial direction. Or we can go for a diagonal when the specific speed is 350 and for very high specific speeds we go for a propeller pump.

(Refer Slide Time: 40:55)

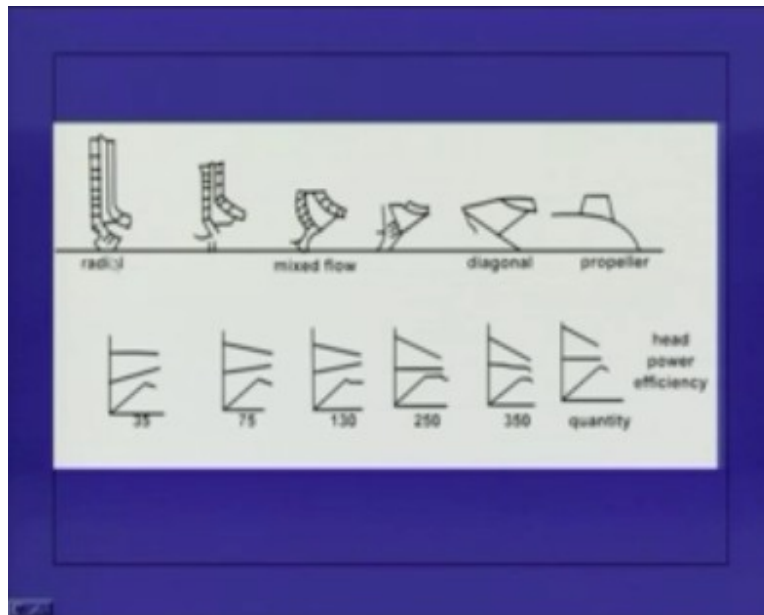

Here in this figure there are three curves. On the x axis we actually plot the discharge and on the y axis we plot the first curve which is for the head, this curve is head versus discharge curve (Refer Slide Time: 40:56) for a typical pump which has a specific speed of 35 and this is power versus discharge curve and this one is the efficiency versus the discharge curve. These curves can be plotted for any type of impeller or any pump. You can see, when the specific speed is low the power increases with the discharge, the discharge is on the x axis. So if I want to pump more water and I open my delivery valve then I will be increasing the load on the motor. This has to be considered properly while selecting the motor and designing the motor.

Whereas in this figure here when the specific speed is 350 the power consumption reduces as the discharge goes up. That means when I if I select the motor for very high discharges and then when I operate the pump at very low discharges by throttling the valve then there will be more power when I throttle the valve or when there is a shutoff condition there is overload on the motor. So such pumps when we operate we actually should start the pump with the valve open. Whereas in this particular case when I operate the pump or when I start the pump operation I should keep the delivery valve closed. So how the motor gets selected and what is the power consumption etc depends upon the specific speed we have. The other important point to be considered from this figure is the maximum efficiency. For any given pump the efficiency is maximum at particular discharge value and corresponding the head value. That is what we call the maximum efficiency point or the discharge and head corresponding to the maximum efficiency point is what we call the rated conditions.

(Refer Slide Time: 43:10)

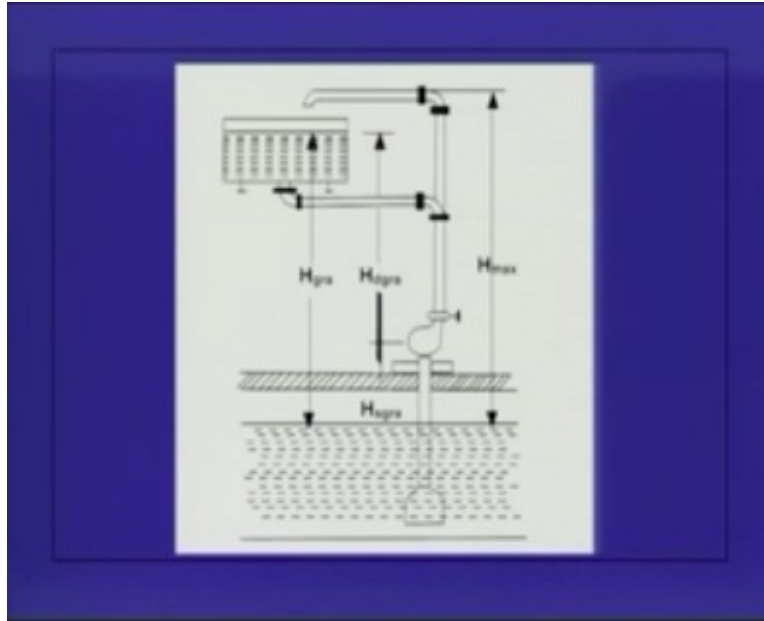

The other important point to be considered while designing these pumps or while selecting these pumps or designing the pumping installations or operation of the pumps is what kind of pressures we have on the suction side of the pump. Let's say this is the pump here, this is the sump, (Refer Slide Time: 43:08) this is the water level in the sump, this is the water level in the delivery reservoir so now at that water level in the sump the pressure is atmospheric whereas on the suction side of the pump pressure will be below atmospheric. This is because as the water goes from this level to this level there is a change in the head so correspondingly the pressure decreases. And also there is head loss in this suction pipe. Because of that on the suction side you always have negative pressures. If the pressure is below the vapor pressure of water then vaporization takes place. That is what we call cavitation.

Cavitation means the bubbling will start occurring and when these bubbles get transported through the pumping system they could reach the regions where pressure could be very high. In such a situation bubbles will collapse this is what we call pitting. If the cavitation occurs in the operation of any pump life of the pump can come down very significantly so a cavitation should be avoided like a plague. If the pressure here or the below atmospheric pressure here itself is very low (Refer Slide Time: 44:30) then one can expect a more significant below atmospheric pressure in the pump. So each pump manufacturer tells you what we call a NPSH required that is Net Positive Suction Head required at the suction side. If the actual pressures are not meeting this minimum NPSH required then the cavitation is likely to occur so pump manufacturers will insist the installation of the pump or the design of the pumps or the design of the suction side such that this NPSH required is always met that is actual net possible suction head or the net positive head should be more than the minimum net positive suction head or the NPSH required.

The NPSH available can be easily determined using the Bernoulli's equation or the engineering Bernoulli's equation between the sump water level on the suction side of the



pump and accounting for the difference in the elevations and the energy loss in the suction pipe. So that NPSHa should be greater than NPSH required. Typical NPSH required curves are given in this figure for centrifugal flow pumps and mixed flow pumps.

(Refer Slide Time: 46:15)

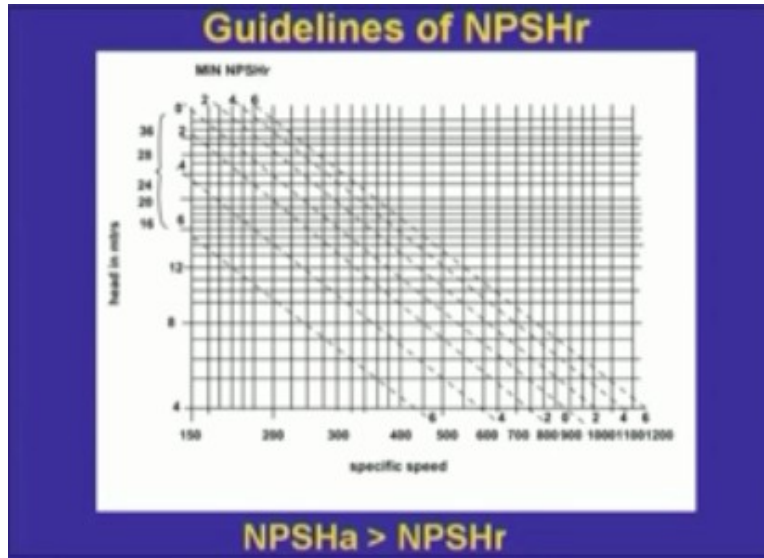

The NPSH required also depends upon the specific speed and the head of pumping which is given in units of meter here. So, if I know what is my specific speed and I know what is the head over in which the lifting is taking place then we can determine the minimum net positive suction head required and then we make sure that pump is installed in a manner that NPSHa is greater than NPSH required.

The other important factor in the pump selection is what we call the operating point. The operating point is the point where when you take a pump and put it in a system and start the pump then (Refer Slide Time: 46:46) this is the operating point which will tell you what discharge you will get and what is the head developed by the pump. Remember the head developed by the pump should be such that it should get over not only the static lift but all the frictional losses and the velocity head at the delivery point.

Let us say your delivery pipe is discharging into atmosphere then there is a certain velocity with which water comes out so there is a velocity head. So the static head plus the friction loss in the delivery pipe plus the velocity head is what we call the system head. Now the system head depends upon the discharge we have in the pipe and typically varies as the quadratic power of discharge or the total head is a function of Q square. So, for different values of Q or for different values of Q we will find out what is the total head in the system and we can plot that curve and that is what we call the system head curve as shown here.

(Refer Slide Time: 47:55)

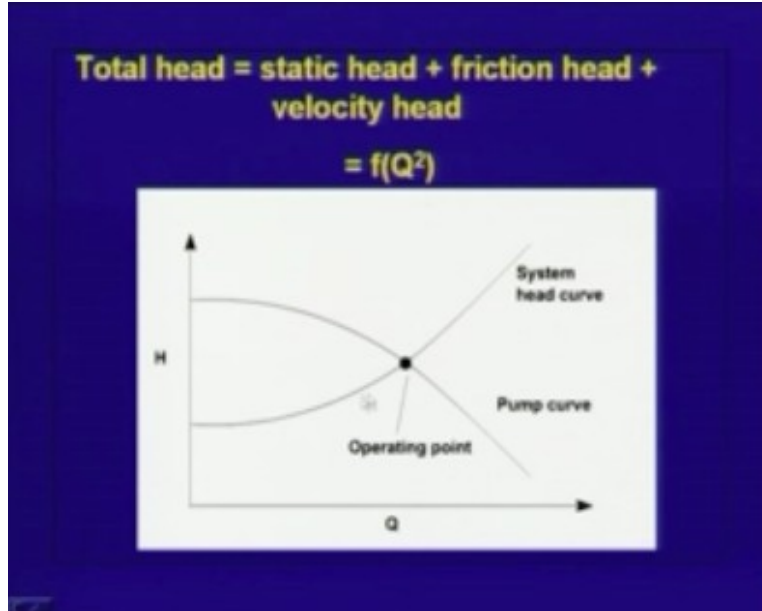

The other curve I am showing in this figure is the pump curve. The pump curve is given by the manufacturer. After designing the pump and fabricating the pump one can conduct a pump test. There are standard procedures available for conducting the pump test. And this head developed by the pump which is equal to the delivery pressure minus the suction pressure which one can easily find out during the pump test by installing a pressure gauge on the delivery side and pressure gauge on the suction side from this one can find out what is the pump head developed. And one can take the flow from the pump and then put it through a discharge measuring device and find out what is the flow that is coming out of the pump during the pump test and one can plot this head developed by the pump as a function of this Q. That is what we call the pump curve and where the system head curve intersects the pump curve is what we call the operating point.

So this is the operating point (Refer Slide Time: 49:07). That means irrespective of what the rated head is or what the rated flow rate is the pump will be operating such that this is the discharge you get and this is the head developed by the pump. Now this operating point should coincide with the best efficiency point or the rated point if you have selected the pump properly or if you have designed the pump properly to suit the given system. During the life cycle of the pump the water level in the sump could be varying between two limits; a low water limit and a high water limit.

(Refer Slide Time: 49:55)

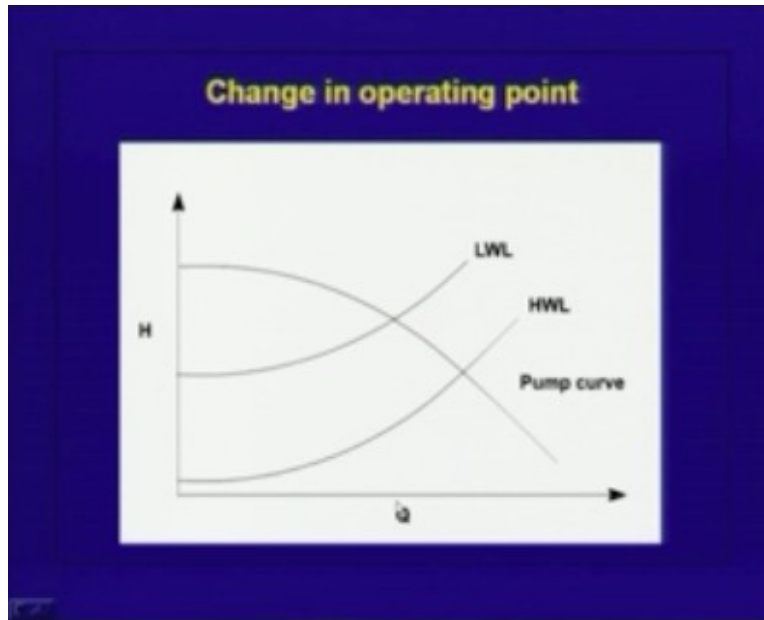

When the water level in the pump is very low then the static lift increases and when the pump is operating under such conditions you will get a low discharge to balance for the high head. Whereas when we have high water level in the sump then the static lift is reduced and to compensate for reduced total head the discharge will increase. So the pump will be operating between this operating point and this operating point during the operation corresponding to low water level and high water level.

Pump efficiency curve: We have seen that the efficiency varies with the discharge and depending upon the specific speed of the pump. Now the pump should be selected or should be designed or we should take such a pump such that the efficiency versus the discharge curve (Refer Slide Time: 50:45) let's say this is the efficiency versus the discharge curve the efficiency is more or less maximum between the low water level and high water level and that efficiency curve is more or less flat between these two points that's a very important point in the selection of the pumps.

The other important consideration is the sump design. Whenever we are designing the sump the sumps should be designed in such a manner that it prevents vortex formation. If vortex gets formed in the sumps then that vortex can entrain the air not only that the turbulence that is created the disturbance that is created can have significant effect on the pump operation or the flow structure within the pump and that affects the efficiency of the pump. The other thing is if you are having more than one pump or three or four pumps which is operating in parallel then we have to get a uniform flow distribution in the sump.

(Refer Slide Time: 51:50)

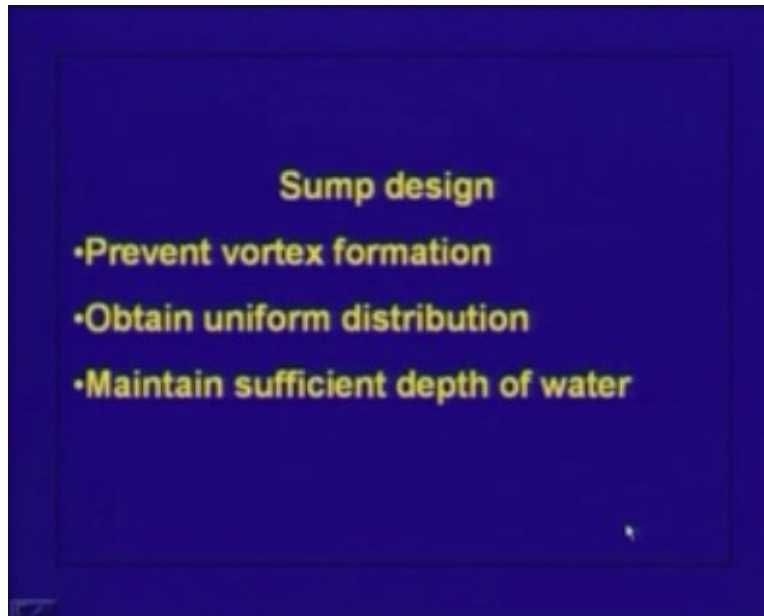

We also have to maintain sufficient depth of water in the sump to prevent air entry. A typical design for a pump sump is like this

(Refer Slide Time: 52:47)

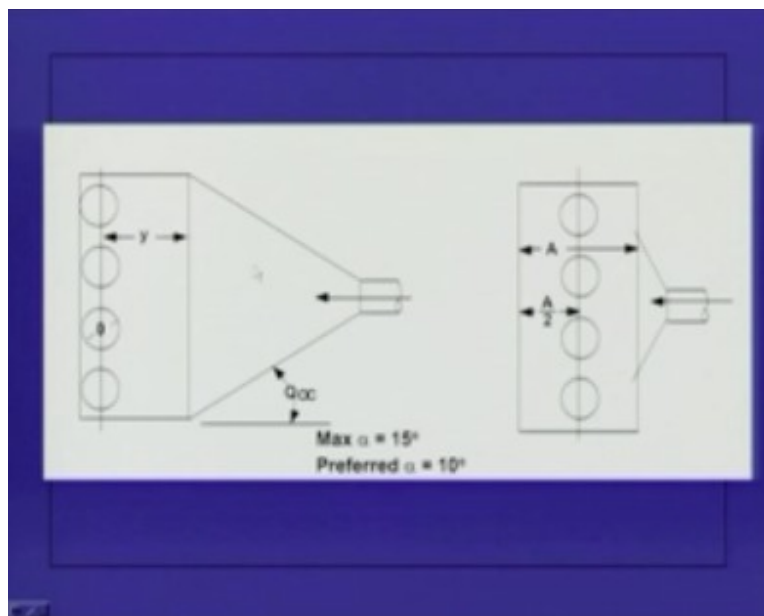

This is my inlet pipe to the sump (Refer Slide Time: 52:02). This is let's say coming from the intake structure and we are operating four pumps in parallel. The sump should be designed such that the flow approaches all these four pumps more or less uniformly and a single pump is not stopped. Sometimes we may have four pumps we may be operating only two pumps. In such a situation also the flow should be approaching these pumps more or less uniformly. So the sump design should be such that even when one or more

pumps are operating or let's say when not all the pumps are operating the flow structure here is conducive to obtain maximum efficiency.

There are limitations on the maximum angle you can take for this expansion here and let's say the preferred angle is ten degrees what should be the spacing between the pumps, what should be the spacing behind the valve behind the pump the pump centre line, what should be the spacing between the pump centre line and this place and what should be distance between this inlet point here (Refer Slide Time: 53:15) and the pump centre line and so on and so forth.

Guidelines available for this purpose: For example one should go for a sump design of this nature or a sump layout of this nature compared to this. This kind of a sump design is not recommended at all. If you look at in the elevation the water will be flowing in this manner from this side to this side. Ahead of the pump we need to put a trash track. For entry into the pump sump we need to have a trash track to eliminate large debris, then we have this screen here which will kill lot of flow disturbances and the water will be entering or approaching the pump more or less uniformly, this screen has to be there. and we need to have enough depth of flow near the pump and that is the reason why we need to have this sloping floor because the depth here could be very low and if I take the floor at this level then we would not have proper entry into the pump.

(Refer Slide Time: 54:20)

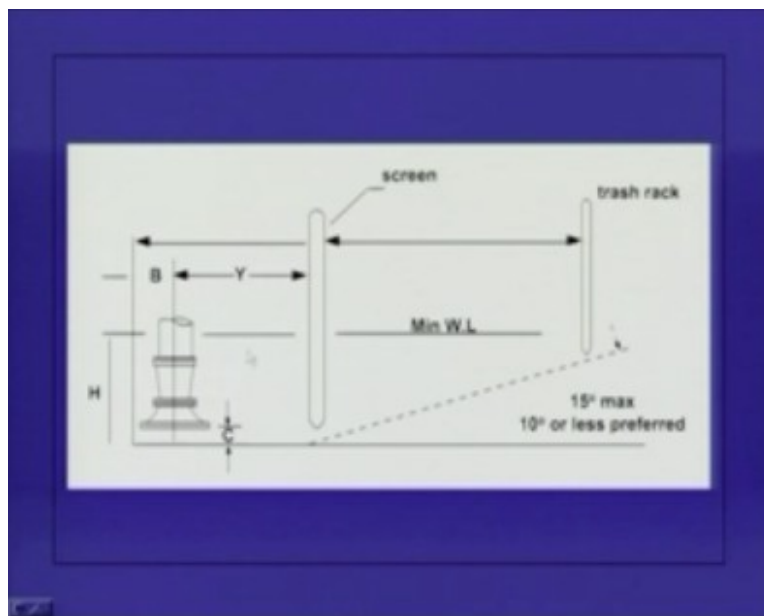

There are conditions on;

- How much of spacing should be there between the bell mouth entry to the pump and the floor
- What is the minimum water level required for the submergence of this bell mouth when we get better efficiency

- What should be the distance between the pump centre line and the trash track and the screens and so on and so forth

In wastewater pumping the principles of pumping are very similar except that the nature of water or quality of water is different and the kind of issues that one has to consider is the release of gases from the wastewater. Particularly when we are talking about sanitary sewerage or when we talk about storm sewerage system the intermittency in the operation is a important consideration. For example, here we are talking about a wastewater pumping. one can have a dry well type of a design, this is called a wet well and this is a dry well, the pumps are located in the dry well, the sewage pipe or the drain pipe which is delivering water into the wet well can have a high level or a low level but we don't put the pump in the wet well itself.

In some installations we can put the pump directly in this wet well and then pump the wastewater out. but here we keep the pump in the dry well and take the suction pipe from the pump to the wet well so that water entry from the wet well into this pump is through this suction pipe. Here this is the motor and the power is supplied to the pump. This is the pump centre line (Refer Slide Time: 56:11) and this is the delivery pipe from the pump.

(Refer Slide Time: 56:10)

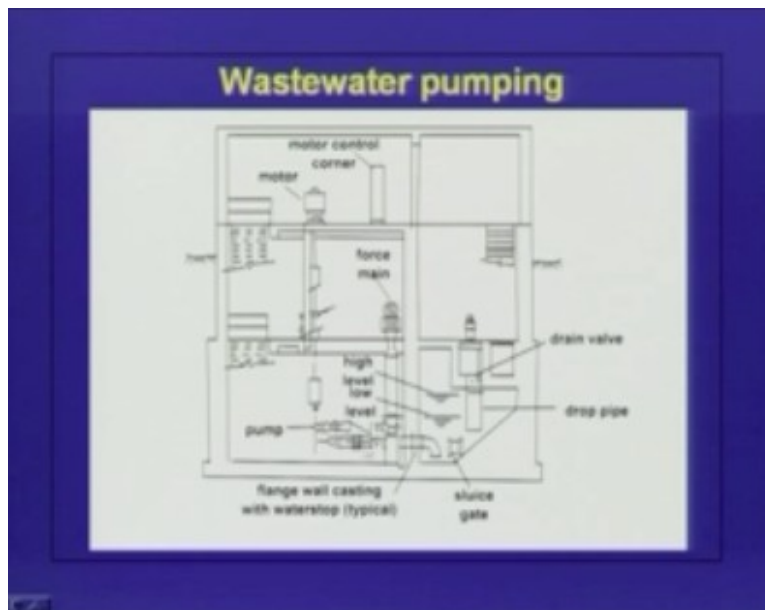

(Refer Slide Time: 57:10)

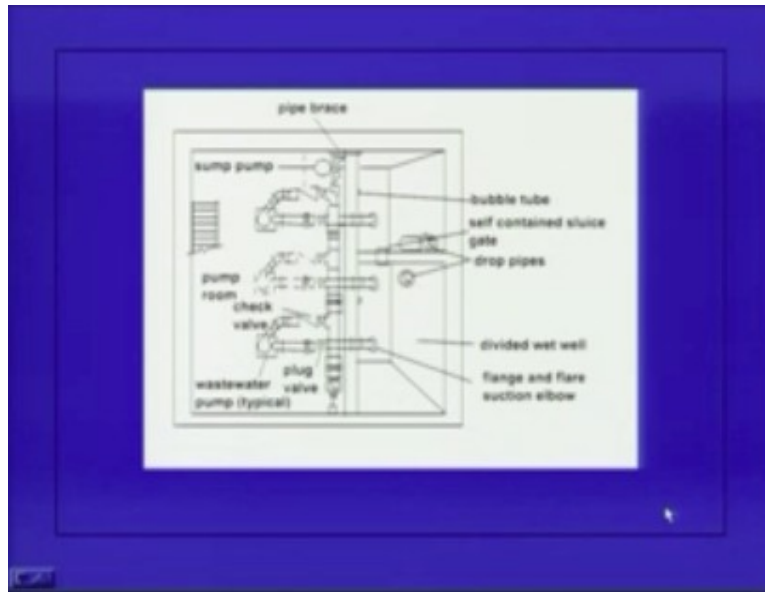

We can also have an installation of this nature where we have three pumps which are operating in parallel. This is what we have, a wet well and this is the dry well (Refer Slide Time: 56:31). All the pumps are located in the dry well and the suction pipes from these are going into the wet well and delivery from the pumps is taken through a check valve and then put in a common header. All these delivery pipes are connected to a common header and this check valve is provided to prevent reverse flow when there is a stopping of the pump. Here there is a bubble tube. This is an important feature that is provided in sanitary sewage pumping. This bubble tube provides the air to the water or wastewater in the wet well so that water quality is maintained and ensures that septic conditions are not set in.

(Refer Slide Time: 57:32)

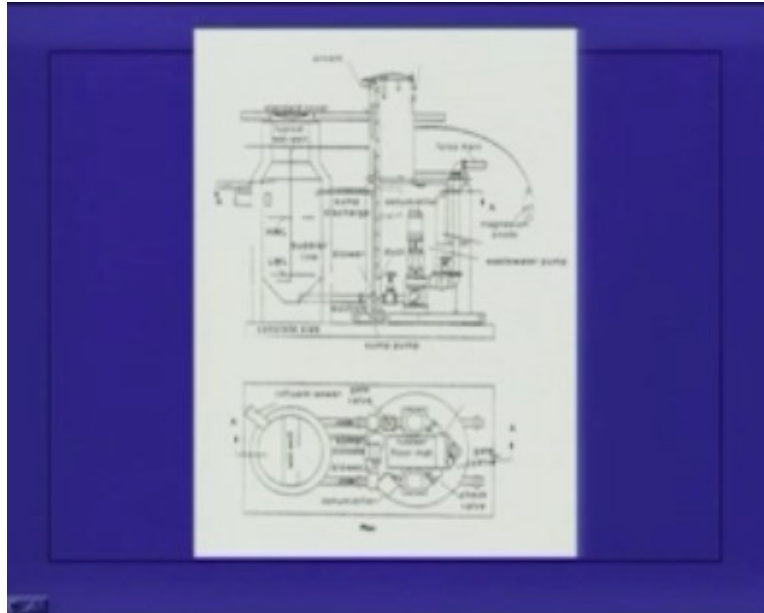

We can also have a wet well dry well type of an installation in this manner. This is the wet well and the suction pipe is going from the wet well to the dry well and the pump is located here. This is a factory assembled sewage pumping station. We can have this kind of a pumping installation for pumping large storm water flows. Here the water is coming from the storm water drain and there is a trash rack here and it enters through the trash rack and we have a pump here, we have to maintain certain minimum depth of flow.

(Refer Slide Time: 58:00)

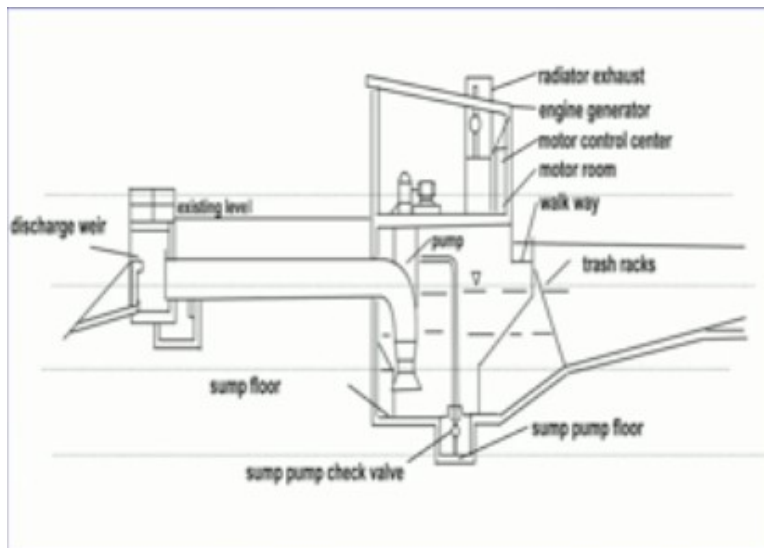

We also have a sump pit here so we have to provide a pump here also to drain for the maintenance purposes.

In this lecture we have seen what are the basic considerations or basic factors that we



consider while designing intakes for a water supply scheme and for designing pumping installations for a water supply scheme or for a wastewater scheme. As I mentioned pumping is required in water supply schemes to maintain certain amount of pressures and for lifting the wastewater whereas pumping is required in wastewater schemes for lifting the sewage from a low level drain to a high level drain. And we have seen where should the intakes be located and how to design the sump and what is the main difference between the pumping of a water supply scheme and the pumping in a wastewater scheme.