

Introductory Neuroscience & Neuro-Instrumentation
Professor Mahesh Jayachandra MBBS MD PhD
Center for Bio-Systems Science and Engineering
Indian Institute of Science, Bangalore
Lecture No. 56
Demonstration: Voltage Clamp

(Refer Slide Time: 0:23)

Introductory Neuroscience & Neuro-Instrumentation:
DEMO: Voltage Clamp

Mahesh Jayachandra MBBS MD PhD

Center for Bio-Systems Science & Engineering (BSSE)
Indian Institute of Science, Bangalore

Mahesh Jayachandra MBBS, MD, PhD | Demo: Voltage Clamp | 17 Sept 2020

So, Introductory Neuroscience and Neuro-Instrumentation: Voltage Clamp Demo.

(Refer Slide Time: 0:24)

Introduction

Hello!

Welcome to a demo of the voltage-clamp experiments of Hodgkin and Huxley (Hodgkin and Huxley, 1952). This technique was crucial in understanding the underlying mechanisms of action potentials generation.

This demo is a complement to the lecture on Action Potentials.

Mahesh Jayachandra MBBS, MD, PhD | Demo: Voltage Clamp | 17 Sept 2020

So, hello! Welcome to a demo on the voltage clamp experiments of Alan Hodgkin and Andrew Huxley. This technique was crucial in understanding the underlying mechanisms of action potentials generation. So, this demo is a complement to the lecture on Action Potentials.

(Refer Slide Time: 0:42)

Software: METANEURON

Newman MH, Newman EA. *MetaNeuron: A Free Neuron Simulation Program for Teaching Cellular Neurophysiology. J Undergrad Neurosci Educ.* 2013;12(1):A11-A17.

- Free, standalone program that can be used without restriction.
- It is used to conduct Neurophysiology experiments *in silico*.
- Works on Windows, Mac and Linux (*via WINE*).

Mahesh Jayachandra MBBS, MD, PhD Demo: Length Constant 17 Sept 2020

So, once again the software we are using for this demo is Metaneuron. It was created by Professors Newman and Newman, The University of Minnesota and published in the journal of Undergrad Neuroscience Education, June in 2013. It is a free standalone program that can be used without restriction. And we can conduct neurophysiology, cellular neurophysiology experiments in silico. It works on Windows, Mac and also on Linux via WINE.

(Refer Slide Time: 1:13)

METANEURON (2)

Neuronal parameters, e.g., Na^+ and K^+ concentrations, equilibrium potentials and conductances can be easily modified.

A virtual stimulator injects single or double current pulses into the neuron.

Responses are displayed graphically and can be measured with a cursor.

Families of traces can be easily generated and viewed in rotatable 3D plots.

Mahesh Jayachandra MBBS, MD, PhD Demo: Time Constant 17 Sept 2020

So, just retreat, the neuronal parameters, example sodium and potassium concentrations, their equilibrium potentials and the conductances can easily be modified. A virtual stimulator injects single or double current pulses into the neuron. Responses are displayed graphically and can be measured with a cursor. And families of traces can be easily generated and viewed in a rotatable 3D plot.

(Refer Slide Time: 1:42)

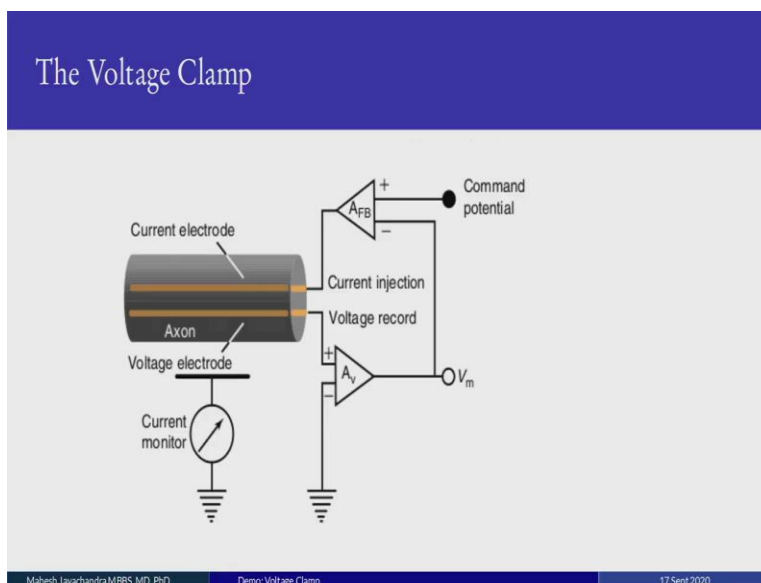

Just to remind you this is the schematic of a voltage clamp experiment. So, you have the axon and you have two electrodes inter cellular electrodes, one is voltage electrode which senses

voltage and the other is current electrode to inject current. So, just to remind you the voltage the resting membrane potential is let us say minus 60 millivolts.

So, we can change and hold clamp the voltage at different points like minus 60, minus 50, minus 40 so on and so forth. And when we hold it at this level, the voltage at this level, we inject current so that it stays at this level. So, it is called the voltage at which the axon is held is called the command voltage.

So, to compensate for the membrane conductance on the ionic currents you inject an appropriate amount of current at a particular voltage. And then you can work out the relationship between the current needed at a particular voltage. This is what Hodgkin and Huxley did, they used a squid joint axon which if you remember is about 1 millimeter in diameter that is a 1000 mu microns and it was easy, relatively easy, nothing is easy. This is relatively easy to insert the current electrode and the voltage electrode into such a big preparation.

(Refer Slide Time: 3:14)

Voltage Clamp Demo Utility

This demo helps us understand:

- 1) The rationale of the voltage-clamp technique
- 2) The voltage- and time-dependent properties of Na⁺ and K⁺ channels.

Here stimuli control the command voltage at which the axon membrane potential is held.

Mahesh Jayachandra MBB5, MD, PhD Demo: Voltage Clamp 17 Sept 2020

So, this demo, what is the use of this demo? So, it helps us to understand the rationale of the voltage-clamp technique and the voltage and time-dependent properties of the sodium as well as the potassium channels. So, here the stimuli control the command voltage at which the axon membrane potential is held.

(Refer Slide Time: 3:35)

The Voltage Clamp gives much information

- 1) Measurement of the Na⁺ and K⁺ currents
- 2) Graphing current vs. voltage relations
- 3) Calculation of conductance vs. voltage relations
- 4) Plotting the time course of recovery of Na⁺ channels from inactivation using a two-pulse stimulus protocol.
- 5) The temperature-dependence of channel kinetics. The slowing of K⁺ channel activation and Na⁺ channel inactivation with cooling decreases Action Potential threshold. *Basis of Multiple Sclerosis therapy.*

Mahesh Jayachandra MBBS, MD, PhD Demo: Voltage Clamp 17 Sept 2020

So, we get lots of information from this experiment. First of all we can measure the sodium and potassium currents at different voltages. Then we can graph the current versus voltage relationship. We can calculate conductance versus voltage relationship. If you remember conductance maximum G_{Na} is a sodium conductance and G_{K} is potassium conductance and their G_{max} reflex or is directly proportional to the actual number of sodium channels or potassium channels.

We also plot the time course of recovery of sodium channels from inactivation using a two-pulse stimulus technique and the temperature dependence of channels can be checked out. The slowing of potassium channel activation and sodium channel inactivation with cooling decreases the action potential threshold.

And this is the basis of multiple Sclerosis therapy. If you remember a MS causes demyelination, it is an auto immune disease where the bodies, antibodies attack its own myelin and you have slowing of conduction and then finally conduction failure and it usually affects women in the age group of 20 to 40, it occurs in women and there is no definite therapy, but if you cool the body, you can restore conduction and this is the reason.

(Refer Slide Time: 5:03)

The Voltage Clamp Family of curves

A family of voltage-clamp traces is easily created in by selecting the *Range* function for *Stimulus 1 Amplitude*.

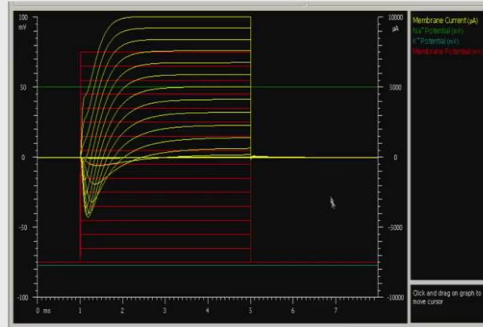

Mahesh Jayachandra MBBS, MD, PhD

Demo: Voltage Clamp

17 Sept 2020

The Voltage Clamp DEMO

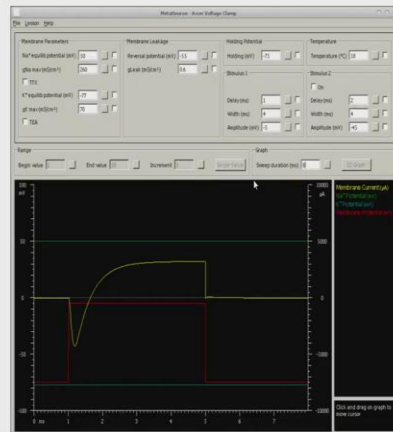

Mahesh Jayachandra MBBS, MD, PhD

Demo: Voltage Clamp

17 Sept 2020

So, we can generate a family of curves by using a different range of amplitudes and we will show you this in the demo and this is the screen for the demo. So, I shall get into the demo without any further.

(Refer Slide Time: 5:24)

Voltage Clamp Exercises

- 1) Na^+ and K^+ voltage clamp currents. A family of voltage clamp traces can be generated in a graph by using the “Range” function.
- 2) Effect of channel blockers TTX and TEA.
- 3) K^+ and Na^+ current-voltage and conductance-voltage relations.
- 4) Recovery from Na^+ channel inactivation.

Mahesh Jayachandra MBBS, MD, PhD Demo: Voltage Clamp 17 Sept 2020

So, the exercise, you can do different exercises. So, one you can generate sodium and potassium voltage clamp currents. And you get as I said, a family of voltage clamp traces by using range functions. You can block sodium currents with tetrotoxin and TTX. And potassium outward currents with tetrahydroammonium and see each current in isolation and you can look at potassium and sodium current voltage and conductance voltage relationships. And you can also look at recovery of sodium channel activation by using two stimuli.

(Refer Slide Time: 6:03)

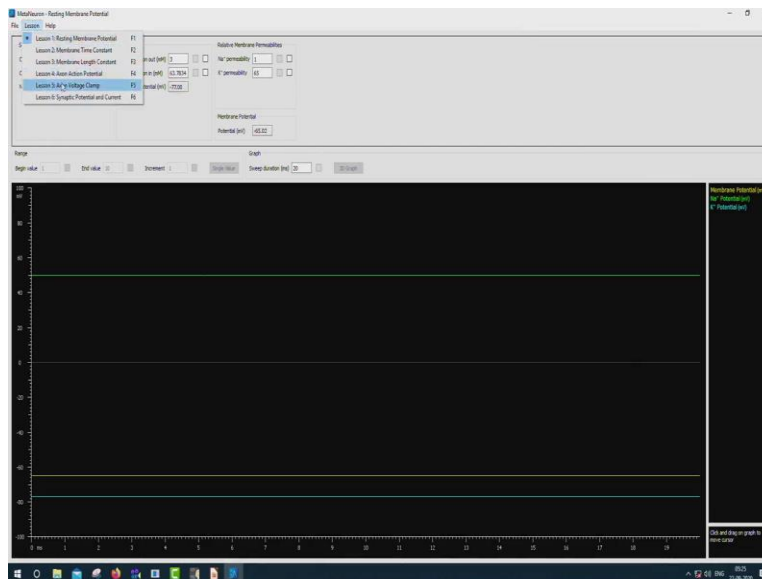

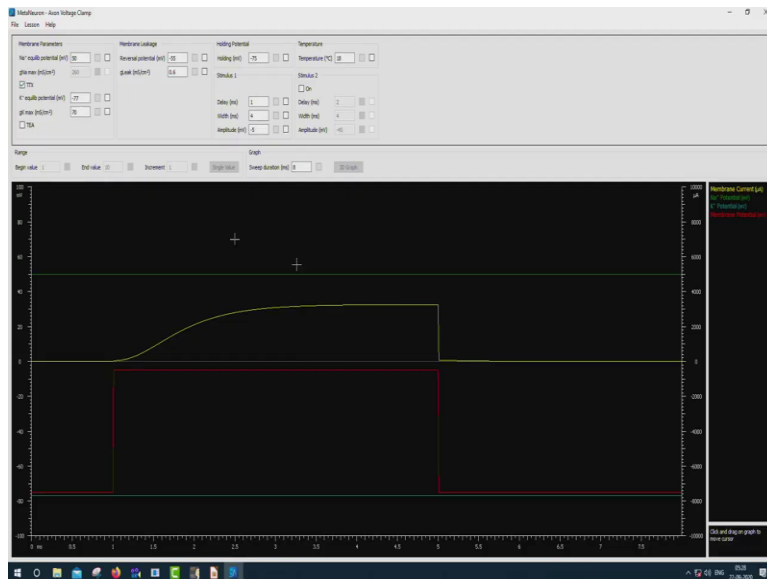
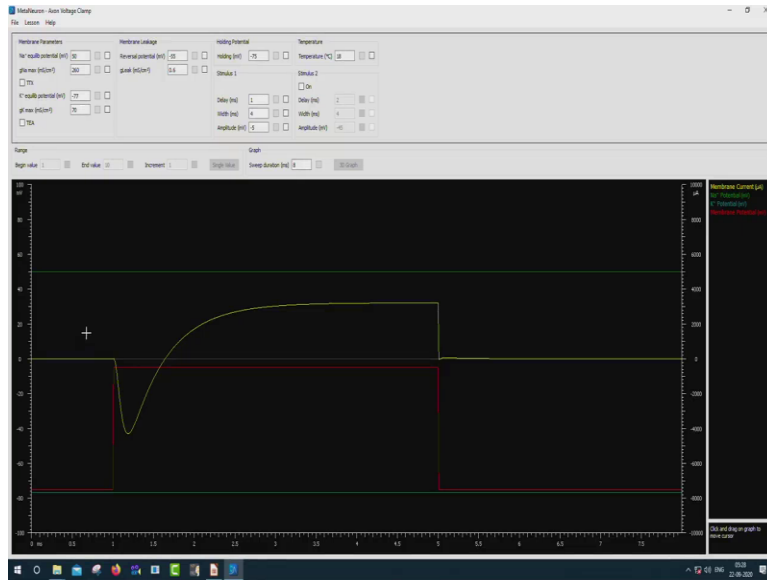

This is the MetaNeuron screen and we choose the lesson 5 which is the axon voltage clamp and here, just to over some of these parameters so the membrane parameters on the extreme left on the top you have the sodium equilibration potential as usual you are keeping at that 50, plus 50. Then we have conductance of sodium so $G_{Na\ max}$ and this is milli cm per centimeter square. So, that is reflex, the total number is proportional to the total number of sodium channels in the axon or membrane, then below that we have the potassium equilibration channel kept at a usual value of minus 77 and then you have the maximum potassium conductance which is 70.

So, then you have the membrane leakage, membrane leakage potentials minus 55 and G_{leak} which is 0.6 or holding potential over here command voltage is at minus 75. And the stimulus 1

we can change its parameters, right now it is set at 1 millisecond, the width is 4 milliseconds and the amplitude this is the one we shall be modifying, minus 5 and the temperature is kept at 18 degree centigrade.

So, coming to the plot below the membrane current is a yellow trace, you see an inward current and you see the out-ward current. The red trace is the membrane potential and that is what we hold it at and we clamp it at this potential and then we release the clamp over here. And the sodium potential is right on top on the equilibration potential and the potassium equilibration potential is in blue below.

So, coming to the membrane current, so this is the membrane potential which is clamped at the red line. So, when it is clamped, you have 1 inward current which is if you remember the sodium current and an outward current which is the delayed rectifier or the potassium current and as soon as the clamp is released it comes back to normal. So, how do we know this is a sodium current? Well, we will it with TTX. And now you have only the sodium currents have been blocked and you just have the delayed rectifying potassium current.

(Refer Slide Time: 8:34)

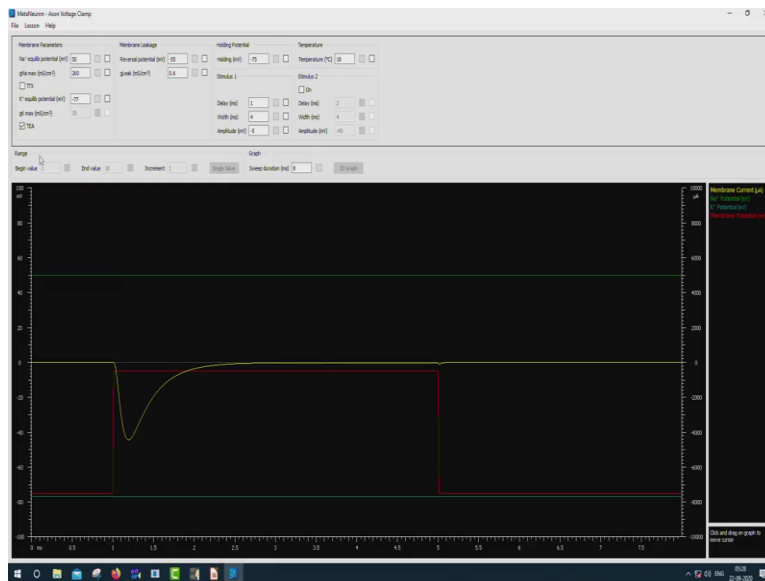

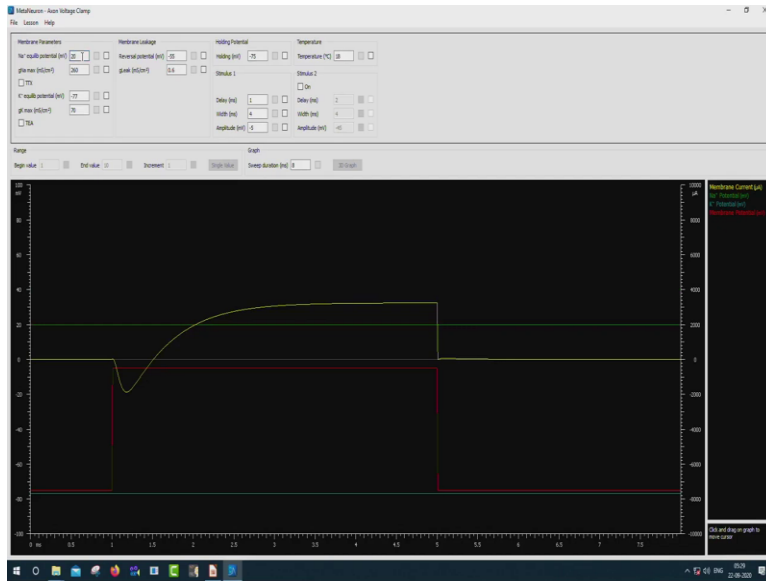
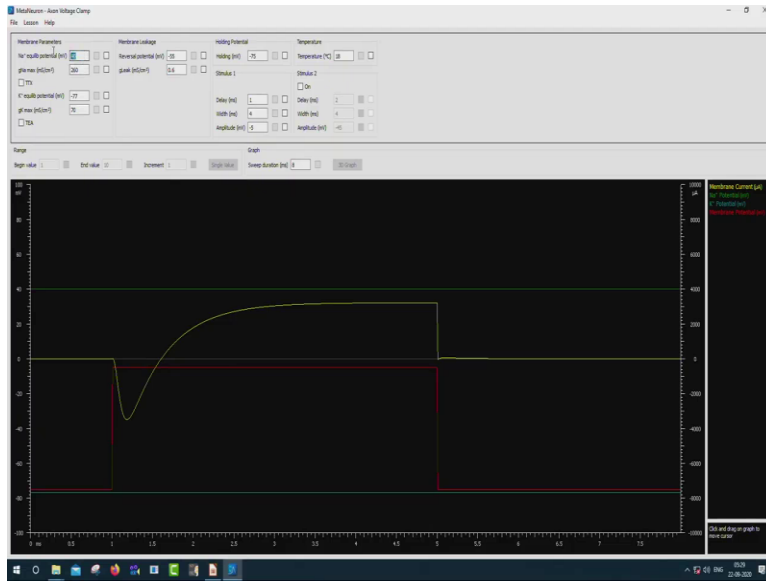

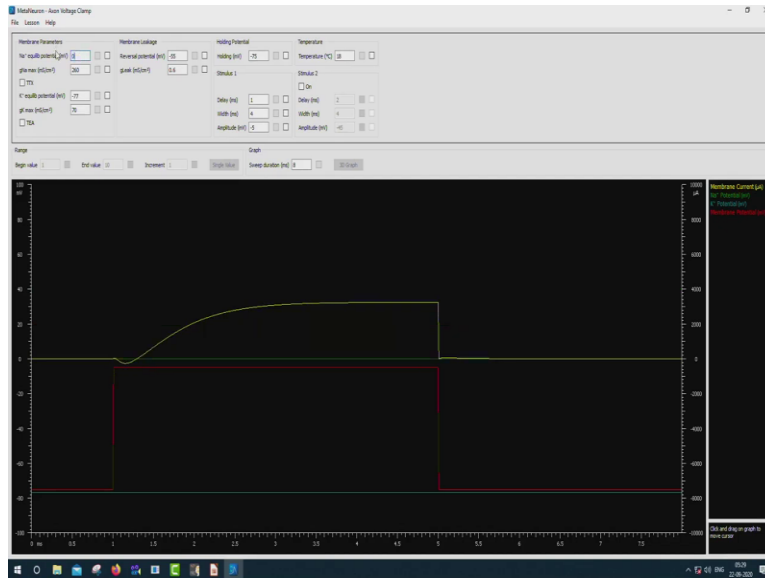

So, we started again and we now block the potassium current so now you see only the inward sodium current. So, sodium activation and sodium inactivation, it inactivates and even though it is held the membrane potential is held at this level it has inactivated. So, let us bring it back. So, again you can vary the different ions, ionic concentrations inside and outside the cell.

So, basically what you are doing is you are varying the sodium equilibration potential so let us see what happens. So, we change it to 40. So, becomes much less the inward current becomes much less. Let us go back let us make it 20 so it becomes even less and when we completely makes it 0 is a little dip that is it.

(Refer Slide Time: 9:34)

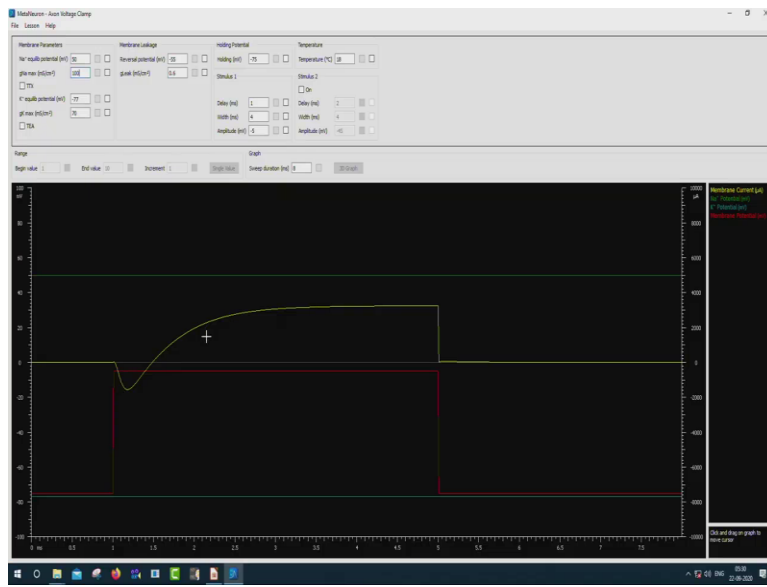
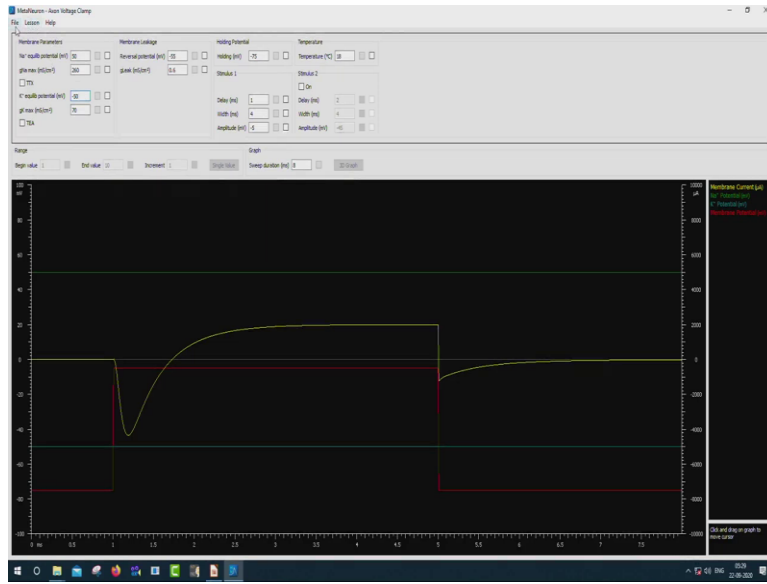

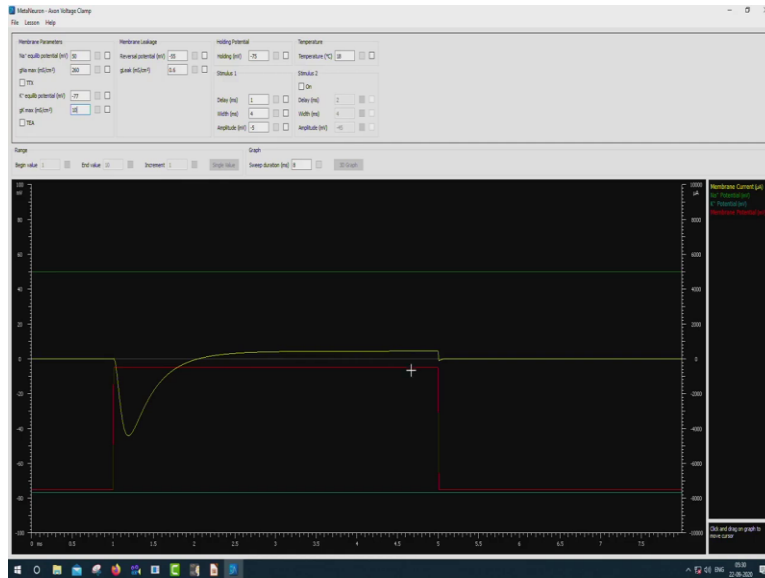

So, let us go back to defaults and we can do the same thing with the potassium equilibration potential. So, if we change this to minus 50. So, you see the equilibration goes up the potassium equilibration current goes up and also the outward current decreases. So, like this you can change the different parameters, you can also change the potassium conductance, sodium conductance, decrease the number of channels so let us do that, let us make it 100.

So, what we have done over here is we have decreased the number of, effectively we have decrease the number of sodium channels. So, the inward current is much less because the fewer channels through which the sodium current can flow. So, we will restore it all to defaults and likewise we decrease the potassium conductance and the outward current decreases, the inward current remains unaffected but the outward current which goes through the potassium channel decreases. Again what we have done is we have reduced the number of potassium channels.

(Refer Slide Time: 10:50)

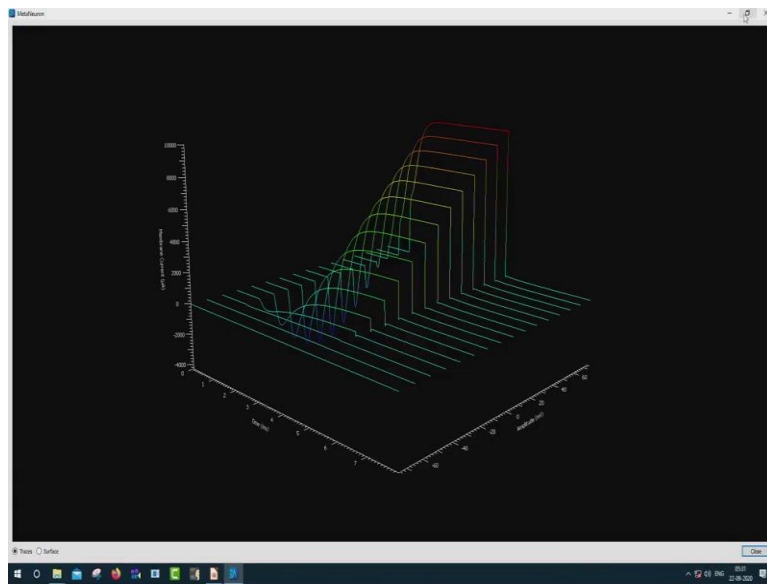
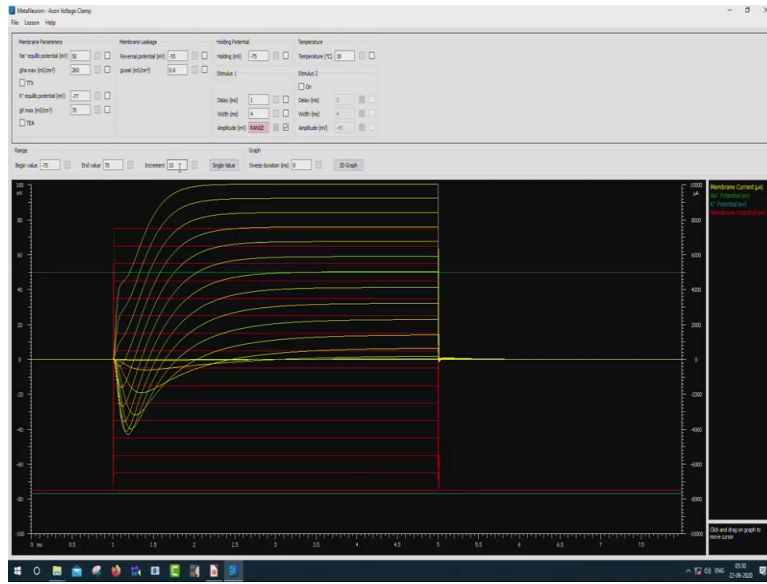

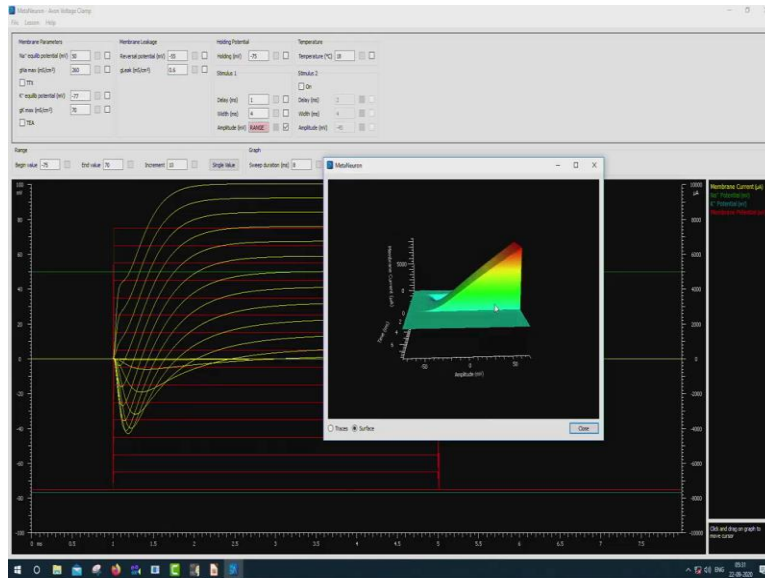

So, let us do a family of curves. So, we change the amplitude, we have a range and now we have a range of beginning values minus 75, the end value is plus 70, and we incremented by 10. And you see this graph. We can also get a surface plot which I do not find very helpful but to get a graphical representation in 3D of the different command potentials.

(Refer Slide Time: 11:53)

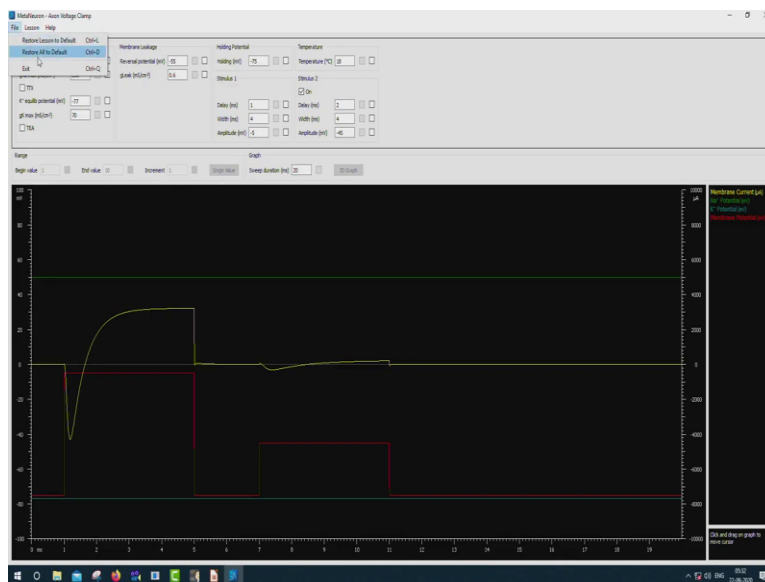

So, we can also, let us go back to normal, we restore all to defaults, we can change the sweep duration to let us say 20. And we can have a second stimulus. So, here you have, you can look at the inactivation this first stimulus causes the inward current and the outward current, the second stimulus if it comes really close to the first one. It is the sodium channels are still inactivated so

there is hardly any sodium activated and because of that hardly any inward current is hardly any outward current.

So, this is basically a demo on the voltage clamp and what is amazing is that if you actually measure a squid axon and look at the values got by the demo, they pretty much coincide and which is amazing thing that the mathematics, the partial differential equations which govern this phenomena describe what happens nearly 100 percent. So, what it means is you do not have to go to the trouble of getting a squid and doing intercellular experiments, you can get an idea what is happening just by doing this demo.